

JVC

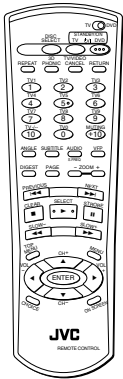

DVD AUDIO/VIDEO PLAYER

XV-FA90BK/XV-FA92SL



INSTRUCTIONS

Introduction	2
Preliminary knowledge	6
Getting started	17
Basic operations	26
Advanced operations	32
MP3 disc playback	54
Initial settings	57
Additional information	67

For Customer Use:

Enter below the Model No. and Serial No. which are located on the rear, bottom or side of the cabinet. Retain this information for future reference.

Model No. _____

Serial No _____

LET0191-004A

[B]

Warnings, Cautions and Others

IMPORTANT for the U.K.

DO NOT cut off the mains plug from this equipment. If the plug fitted is not suitable for the power points in your home or the cable is too short to reach a power point, then obtain an appropriate safety approved extension lead or consult your dealer.

BE SURE to replace the fuse only with an identical approved type, as originally fitted.

If nonetheless the mains plug is cut off ensure to remove the fuse and dispose of the plug immediately, to avoid a possible shock hazard by inadvertent connection to the mains supply.

If this product is not supplied fitted with a mains plug then follow the instructions given below:

IMPORTANT.

DO NOT make any connection to the terminal which is marked with the letter E or by the safety earth symbol or coloured green or green-and-yellow.

The wires in the mains lead on this product are coloured in accordance with the following code:

Blue : Neutral
Brown : Live

As these colours may not correspond with the coloured markings identifying the terminals in your plug proceed as follows:

The wire which is coloured blue must be connected to the terminal which is marked with the letter N or coloured black.

The wire which is coloured brown must be connected to the terminal which is marked with the letter L or coloured red.

IF IN DOUBT - CONSULT A COMPETENT ELECTRICIAN.

CAUTION

To reduce the risk of electrical shocks, fire, etc.:

1. Do not remove screws, covers or cabinet.
2. Do not expose this appliance to rain or moisture.

Caution: STANDBY/ON button!

Disconnect the mains plug to shut the power off completely (the STANDBY/ON lamp goes off).

The STANDBY/ON  button in any position does not disconnect the mains line.

- When the unit is on standby, the STANDBY/ON lamp lights red.
 - When the unit is turned on, the STANDBY/ON lamp lights green.
- The power can be remote controlled.

CAUTION:

Do not block the ventilation openings or holes.

(If the ventilation openings or holes are blocked by a newspaper or cloth, etc., the heat may not be able to get out.)

Do not place any naked flame sources, such as lighted candles, on the apparatus.

When discarding batteries, environmental problems must be considered and local rules or laws governing the disposal of these batteries must be followed strictly.

Do not use this apparatus in a bathroom or places with water.

Also do not place any containers filled with water or liquids (such as cosmetics or medicines, flower vases, potted plants, cups, etc.) on top of this apparatus.

Caution: Proper Ventilation

To avoid risk of electric shock and fire and to protect from damage.

Locate the apparatus as follows:

- Front: No obstructions open spacing.
Sides: No obstructions in 3 cm from the sides.
Top: No obstructions in 5 cm from the top.
Back: No obstructions in 15 cm from the back
Bottom: No obstructions, place on the level surface.

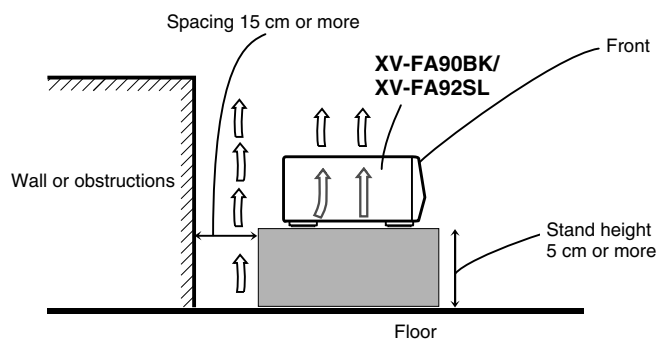

IMPORTANT FOR LASER PRODUCTS

REPRODUCTION OF LABELS

① CLASSIFICATION LABEL, PLACED ON REAR ENCLOSURE

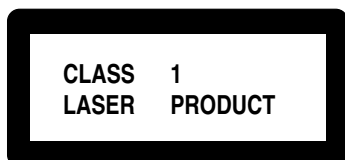

② WARNING LABEL, PLACED INSIDE THE UNIT

<p>CAUTION: Invisible laser radiation when open and interlock failed or defeated. AVOID DIRECT EXPOSURE TO BEAM. (e)</p>	<p>WARNING: Osynlig laserstråling når denna del är öppnad och spriden är urkopplad. Betrakta ej strålen. (s)</p>	<p>ADVARSEL: Usynlig laserstråling ved åbning, når sikkerhedsafbrydere er ude af funktion. Undgå udsættelse for stråling (d)</p>	<p>VARO: Avattaessa ja suojalukitus ohitettaessa olet alttiina näkymättömille lasersäteille. Katso suhteeseen. (f)</p>
---	---	---	---

1. CLASS 1 LASER PRODUCT
2. **DANGER:** Visible and invisible laser radiation when open and interlock failed or defeated. Avoid direct exposure to beam.
3. **CAUTION:** Do not open the top cover. There are no user serviceable parts inside the Unit; leave all servicing to qualified service personnel.

Table of Contents

Introduction Page 2

Features.....	2
Supplied accessories.....	3
About this instruction manual.....	4
Notes on handling.....	5

Preliminary knowledge Page 6

Names of parts and controls.....	6
Front panel.....	6
Display window.....	7
Remote control unit.....	8
Rear panel.....	10
Operational Principles.....	11
On-screen displays.....	11
To prevent the monitor from burning out [SCREEN SAVER].....	13
On-screen guide icons.....	14
How to use numeric buttons.....	14
About discs.....	15
Playable disc types.....	15
Audio formats.....	15
Disc structure.....	16

Getting started Page 17

Connections.....	17
Before making any connections.....	17
To connect to a conventional TV.....	17
To connect to a TV with the SCART connector.....	18
To connect to an audio amplifier or receiver.....	19
To connect to an amplifier/receiver equipped with 5.1-channel inputs.....	20
To connect to audio equipment with a digital input.....	21
Using the remote control unit.....	22
To connect the power cord.....	22
To install batteries in the remote control unit.....	22
Remote sensor.....	23
To use the remote control unit for TV operation.....	24

Basic operations Page 26

Turning on/off the unit.....	26
Inserting and removing discs.....	26
Basic playback.....	28
To start playback.....	28
To stop playback completely.....	29
To stop playback temporarily.....	29
To advance or reverse playback rapidly while monitoring.....	29
To locate the beginning of the scene or song.....	30
Changing discs during playback [PLAY EXCHANGE].....	30
Resuming playback.....	31
To memorize the interrupted position.....	31
To resume playback.....	31

Advanced operations Page 32

Playing from a specific position on a disc.....	33
To locate a desired scene from the DVD menu.....	33
To locate a desired scene from the menu of the Video CD with PBC.....	33
To locate a desired selection using the numeric buttons.....	34

To locate a desired selection using ◀◀ or ▶▶.....	35
To specify a desired chapter/track from the on-screen display [CHAP. SEARCH/TRACK SEARCH].....	35

To locate a desired position in the current title or track [TIME SEARCH].....	36
To locate a desired scene from the display [DIGEST].....	37

Special picture playback..... 38

To advance a still picture frame-by-frame.....	38
To display continuous still pictures [STROBE].....	38
To playback in slow-motion [SLOW].....	38
To zoom in/out [ZOOM].....	39

Changing the playback order..... 40

To playback in the desired order [PROGRAM].....	40
To playback in random order [RANDOM].....	41

Repeat playback..... 42

To repeat the current selection or all tracks [REPEAT].....	42
To repeat a desired part [A-B REPEAT].....	43

Selecting a scene angle of DVD VIDEO..... 44

To select a scene angle from the normal screen [ANGLE].....	44
To select a scene angle from the angle list display [ANGLE].....	45

Changing the language and sound..... 46

To select the subtitle language [SUBTITLE].....	46
To change the audio language or sound [AUDIO].....	47

Miscellaneous functions..... 48

To adjust the picture character [VFP].....	48
To simulate surround sound [3D PHONIC].....	49
To check the disc time [TIME SELECT].....	50
To select a still picture on a DVD AUDIO disc [PAGE].....	51
To playback a bonus group of a DVD AUDIO disc.....	52
Changing the brightness of the display window.....	52
Checking the sampling frequency.....	53

MP3 disc playback Page 54

About MP3 disc..... 54

Operations..... 54

Basic operations.....	54
Specifying the desired Group and Track.....	55
Repeat playback.....	56

Initial settings Page 57

Selecting preferences..... 57

How to set preferences.....	57
Language and display preference.....	57
Audio and system preference.....	59
Speaker setting.....	62

Limiting playback by children..... 64

To set Parental Lock for the first time [PARENTAL LOCK].....	64
To change the settings [PARENTAL LOCK].....	65
To temporarily release the Parental Lock [PARENTAL LOCK].....	66

Additional information Page 67

Care and handling of discs..... 67

Troubleshooting..... 68

Specifications..... 69

Table of languages and their abbreviations.. Appendix A

Country code list for Parental Lock..... Appendix B

Features

This unit is a compatible player for DVD VIDEO, DVD AUDIO, Audio CD and Video CD discs.

Picture features

■ Special picture playback

Provides special picture playback functions such as Strobe, Frame-by-frame, Zoom and Slow-motion.

■ Angle function*

You can select a desired angle from multiple camera angles recorded on the DVD VIDEO disc.

■ VFP (Video Fine Processor) function

You can adjust the picture character according to the type of programming, picture tone or personal preferences.

■ Parental Lock*

You can restrict the playback of DVD VIDEO discs with scenes which you do not want children to see, such as adult or violent films.

Audio features

■ High quality digital sound

Supports audio formats for DVD AUDIO including high sampling frequencies up to 192 kHz, the linear PCM multichannel format, up to 24-bit resolution and MLP, as well as the audio formats for DVD VIDEO such as Dolby Digital 5.1 ch., MPEG Multichannel and DTS.

• DOLBY DIGITAL

A surround audio format configured with six channels. Because the "sub-woofer" channel, one of the six channels, is an auxiliary channel, this format is called "5.1-channel system."

• DTS (Digital Theater Systems)

A surround audio format configured with six (5.1) channels which is same as Dolby Digital. Because the compression ratio is lower than Dolby Digital, it provides wider dynamic range and better separation.

• MPEG Multichannel

A surround audio format which can handle the augmentative 7.1-channel format (rare for home use), as well as 5.1-channel.

• MLP (Meridian Lossless Packing)

A format for DVD AUDIO with the compression ratio of about 2:1 while allowing the PCM signal to be completely recreated by the MLP decoder (required in all DVD AUDIO players). It supports up to 192kHz/24-bit.

• Linear PCM

Uncompressed digital audio, the same format used on CDs and most studio masters.

DVD AUDIO supports up to 6 channels at sample rates of 48/96/192 kHz (also 44.1/88.2/176.4 kHz) and sample sizes of 16/20/24 bits, while DVD VIDEO supports 2 channels at sample rates of 48/96 kHz and sample sizes of 16/20/24 bits.

Audio CD/Video CD is limited to 2 channels, 44.1 kHz at 16 bits.

■ Multichannel audio outputs

Provides the multichannel (5.1) analog audio outputs, as well as the PCM/Bitstream digital audio outputs.

■ 3D PHONIC function

You can enjoy Virtual surround sound with your 2 channel (stereo) system.

Other features

■ Multi-disc tray and continuous playback

You can set up to 7 discs on the disc tray carousel and playback them continuously.

■ MP3 disc playback

This unit can playback CD discs recorded by the MP3 format (we refer to those discs as "MP3 discs" in this manual).

■ CD-R/CD-RW playback

You can playback a CD-RW disc recorded with the Audio CD format, and a CD-R disc recorded with the Audio CD, Video CD or MP3 format.

■ Multi-language subtitles and sound*

You can select a subtitle or sound language from those recorded on the DVD VIDEO disc.

■ Operation from the on-screen display

User-friendly on-screen displays allow you to operate the unit easily.

Functions with (*) mark only work on a DVD VIDEO disc that is compatible with each function.

Supplied accessories

- Audio/video cable (x 1)

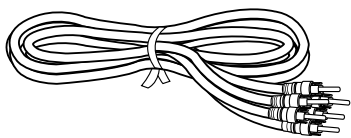

- S-video cable (x 1)

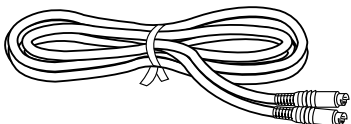

- Audio cable (x 2)

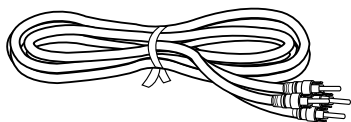

- Remote Control Unit (x 1)

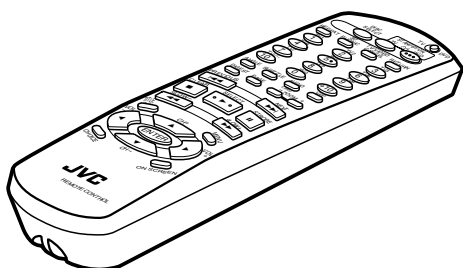

- R6P(SUM-3)/AA(15F) batteries (x 2)

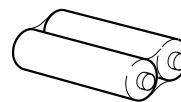

- Instruction manual (x 1)

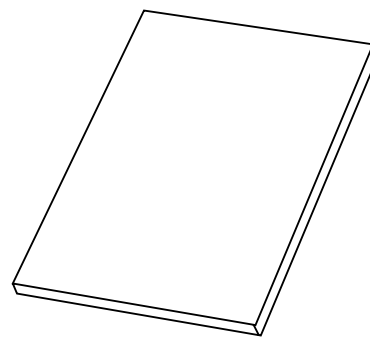

- AC power cord (x 1)

About this instruction manual

- This instruction manual is written in the following manner.
- This unit can playback CD-R discs recorded by the MP3 format (we refer to those discs as MP3 discs in this manual).
- Regarding operations for MP3 discs, see "MP3 disc playback" on and after page 54. The other sections of this manual basically do not refer to MP3 disc playback.

To select a scene angle from the angle list display [ANGLE]



These symbols indicate the types of discs which the operation can be used for.

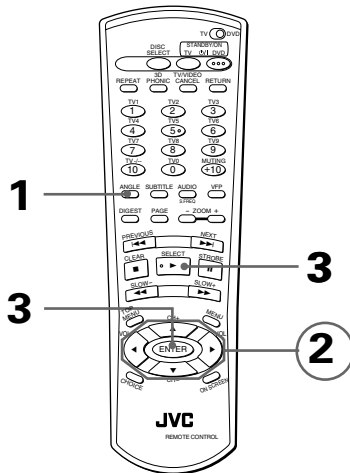

The number indicates the following procedural step(s) in which the button(s) is(are) used. You may also use the corresponding buttons on the front panel of the unit if available.

The number indicates the procedural step.

- During DVD VIDEO playback
- 1** Press and hold ANGLE for more than 1 second.

Up to nine camera angles recorded on a disc appear on the TV screen.

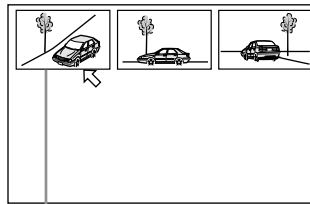

The selected camera angle

- 2** Use CURSOR ▲/▼/◀/▶ to select the desired angle.

- 3** Press ENTER or ▶.

The unit starts playback by the selected angle on the full-sized screen.

The names of buttons on the remote control unit (or on the front panel of the unit) are all given in uppercase letters.

Other convenient procedures, etc.

NOTES

- When appears on the TV screen in step 1: The current scene is not recorded from multiple angles.
- During the operation above, audio is muted.

Notes on handling

Important cautions

Installation of the unit

- Select a place which is level, dry and neither too hot nor too cold (between 5°C and 35°C).
- Leave sufficient distance between the unit and the TV.
- Do not use the player in a place subject to vibrations.

Power cord

- Do not handle the power cord with wet hands!
- A small amount of power (2.7 W) is always consumed while the power cord is connected to the wall outlet.
- When unplugging the player from the wall outlet, always pull the plug, not the power cord.

To prevent malfunction of the unit

- There are no user-serviceable parts inside. If anything goes wrong, unplug the power cord and consult your dealer.
- Do not insert any metallic object into the unit.
- Do not use any non-standard shape disc available on the market, because it may damage the unit.
- Do not use a disc with tape, seals, or paste on it, because damage to the unit may result.

Note about copyright laws

- Please check the copyright laws in your country before recording from DVD AUDIO, DVD VIDEO, Audio CD, Video CD and MP3 discs. Recording of copyrighted material may infringe copyright laws.

Note about the copyguard system

- The DVD VIDEO disc is protected by the copyguard system. When you connect the unit to your VCR directly, the copyguard system activates and the picture may not be played back correctly.

Safety precautions

Avoid moisture, water and dust

Do not place the unit in moist or dusty places.

Avoid high temperatures

Do not expose the unit to direct sunlight or place it near a heating device.

When you are away

When away on travel or otherwise for an extended period of time, remove the plug from the wall outlet.

Do not insert foreign objects into the unit

Do not insert wires, hairpins, coins, etc. into the unit.

Do not block the vents

Blocking the vents may damage the unit.

Care of the cabinet

When cleaning the unit, use a soft cloth and follow the relevant instructions on the use of chemically-coated cloths. Do not use benzene, thinner or other organic solvents and disinfectants. These may cause deformation or discoloring.

If water gets inside the unit

Turn off the power switch and remove the plug from the wall outlet, then call the store where you made your purchase. Using the unit in this state may cause a fire or electrical shock.

This product incorporates copyright protection technology that is protected by method claims of certain U.S. patents and other intellectual property rights owned by Macrovision Corporation and other rights owners. Use of this copyright protection technology must be authorized by Macrovision Corporation, and is intended for home and other limited viewing uses only unless otherwise authorized by Macrovision Corporation. Reverse engineering or disassembly is prohibited.

Manufactured under license from Dolby Laboratories. "Dolby"; "MLP Lossless" and the double-D symbol are trademarks of Dolby Laboratories.
Confidential unpublished works.

© 1992-1998 Dolby Laboratories. All rights reserved.

Manufactured under license from Digital Theater Systems, Inc. US Pat. No. 5,451,942 and other world-wide patents issued and pending. "DTS"; "DTS Digital Surround"; are trademarks of Digital Theater Systems, Inc.

© 1996 Digital Theater Systems, Inc. All Rights Reserved.

Names of parts and controls

Refer to the corresponding pages indicated in () for details.

Front panel

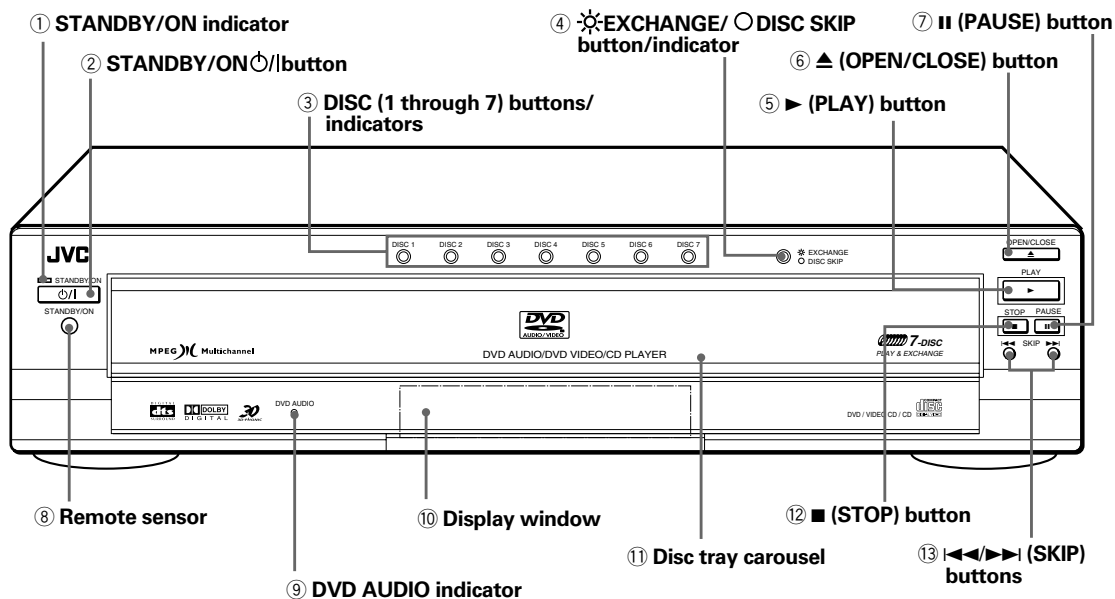

① STANDBY/ON indicator (26)

Lights in red when the power cord is connected and the unit is on standby. When the unit is turned on, the STANDBY indicator lights in green.

② STANDBY/ON button (26)

Turns the unit on or off (standby).

③ DISC (1 through 7) buttons/indicators (28)

Select a disc set on the carousel to be played back by pressing the appropriate button. The indicator on each button shows the current status of the corresponding disc/disc tray.

④ EXCHANGE/ DISC SKIP button/indicator (26, 27, 30)

This button has two functions. When the indicator is illuminated, pressing the button activates the play exchange function. When the indicator is unlit, pressing the button rotates the carousel.

- When the tray carousel is closed during playback, pressing the button activates the play exchange function and opens the carousel.
- When the tray carousel is open during playback, each press of this button rotates the carousel to access other trays except the one for the disc being played.
- When the tray carousel is open while stopped, each press of this button rotates the carousel clockwise by an amount of accessing the next two trays.

⑤ PLAY button (28, 33, 45)

Starts playback. Also, used as a SELECT button for PBC of Video CDs.

- ⑥ **▲ (OPEN/CLOSE) button (26, 27)**
Used to open and close the carousel. You can also use this button in the play exchange mode.
- ⑦ **⏸ (PAUSE) button (29, 38, 54)**
Pauses playback. Also, used to display nine continuous still pictures (STROBE function).
- ⑧ **Remote sensor (23)**
Receives signals from the remote control unit.
- ⑨ **DVD AUDIO indicator**
Lights when a DVD AUDIO disc is loaded.
- ⑩ **Display window (7)**
Indicates the current status of the unit.
- ⑪ **Disc tray carousel (26)**
Used to set up to 7 discs.
- ⑫ **■ (STOP) button (29, 54)**
Stops playback.
- ⑬ **⏮/⏭ (SKIP) buttons (29, 54)**
Used to skip a chapter, title or track. Also, used for the page selection of a menu screen (for Video CD). Holding down ⏮ or ⏭ during playback reverses or advances playback rapidly (except MP3 disc).

Display window

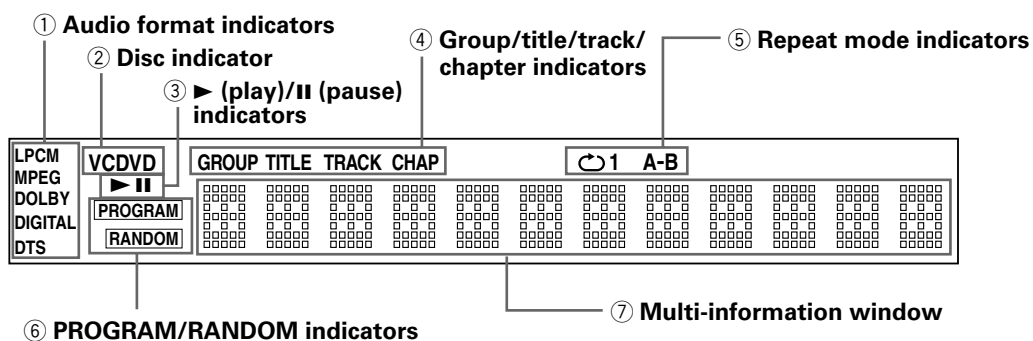

- ① **Audio format indicators**
Indicates the format of audio currently being played back. See "Audio formats" on page 15 for details.
- ② **Disc indicator**
Indicates the type of the disc set in the current tray. When a DVD AUDIO/DVD VIDEO disc is set, "DVD" lights up. When a Video CD disc is set, "VCD" lights up. When an Audio CD is set, "CD" lights up.
- ③ **► (play)/⏸ (pause) indicators**
► or ⏸ illuminates during playback or while paused, respectively. Neither of them illuminates while stopped.
- ④ **Group/title/track/chapter indicators**
One or more appropriate indicators illuminate according to the disc inserted.
- ⑤ **Repeat mode indicators**
The appropriate indicator illuminates according to the current repeat mode.
- ⑥ **PROGRAM/RANDOM indicators**
The appropriate indicator illuminates while the unit is in the Program or Random playback mode.
- ⑦ **Multi-information window**
Displays the current group/title/track/chapter number(s), time and status information.

Remote control unit

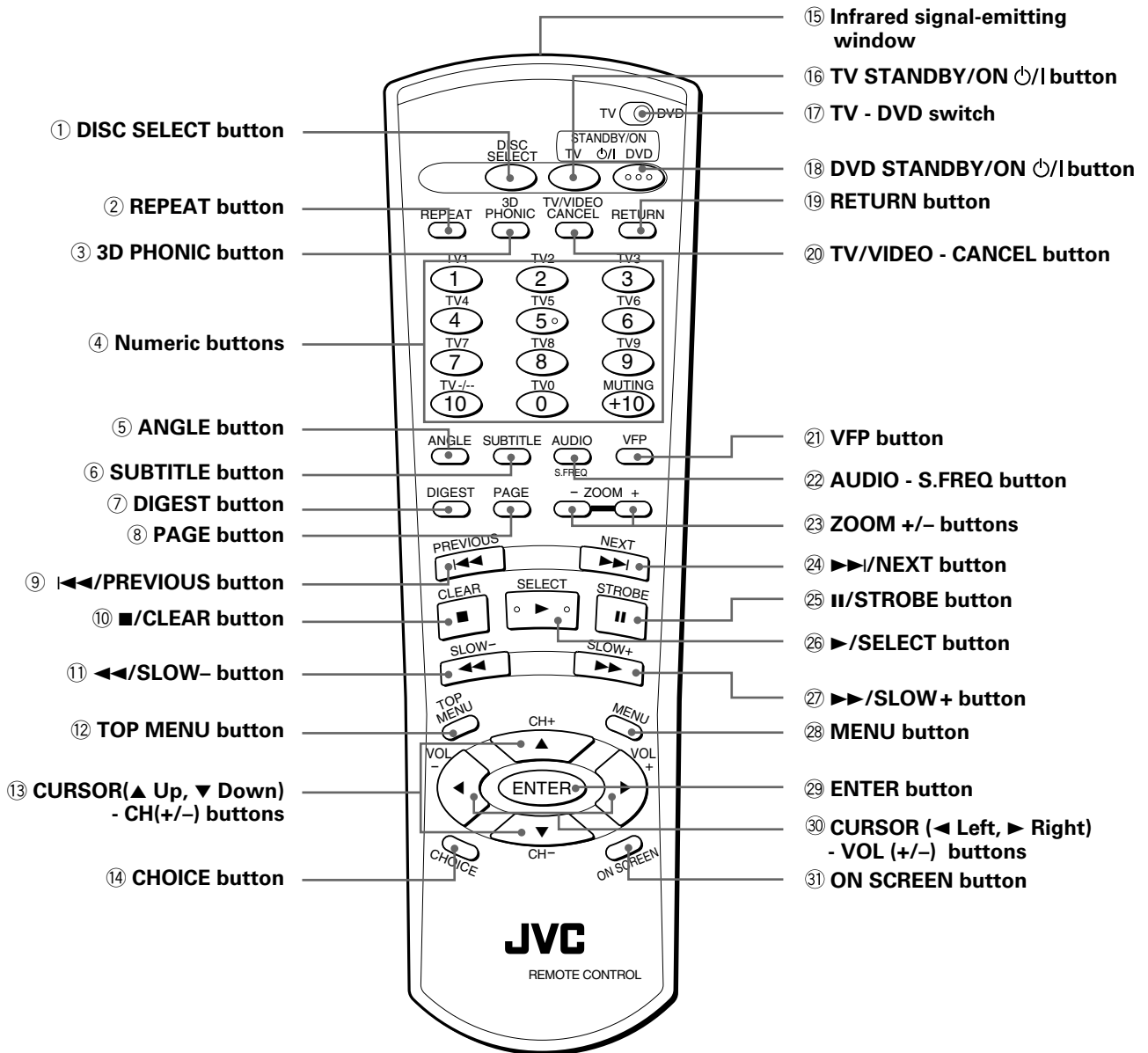

- ① **DISC SELECT button (14, 28)**
Pressing this button followed by the appropriate numeric button (1 through 7) within 5 seconds selects a disc to be played back.
- ② **REPEAT button (42, 56)**
Selects the repeat mode.
- ③ **3D PHONIC button (49)**
Produces a simulated surround effect.
- ④ **Numeric buttons (14, 24)**
When the TV - DVD switch is set to DVD, these buttons are used to select a disc and specify a title, chapter, track or group number, as well as used to select a disc and enter a time for the Time search function. They are also used to select a disc number to be played back in conjunction with the DISC SELECT button. When the TV - DVD switch is set to TV, these buttons are used to select a TV channel as well as mute the TV audio.
- ⑤ **ANGLE button (44, 45, 52)**
Changes camera angles during playback of a DVD VIDEO disc containing multiple camera angles. Also used to change the brightness of the display window.
- ⑥ **SUBTITLE button (46)**
Used to display the subtitle selection display on the TV screen, as well as used to turn the subtitle on or off (for DVD VIDEO).
- ⑦ **DIGEST button (37)**
Displays beginning scenes of each title, chapter or track on the TV screen (for DVD VIDEO/Video CD).
- ⑧ **PAGE button (51)**
Turns the page of B.S.P. (still picture) for a DVD AUDIO disc.

- ⑨ **◀◀/PREVIOUS button (29, 35, 54)**
Skips back a chapter, title, group or track. Also used for the page selection of a menu screen (for DVD VIDEO/DVD AUDIO/Video CD).
Holding down this button during playback reverses playback rapidly (except MP3 disc).
- ⑩ **■/CLEAR button (29, 40, 54)**
Stops playback. Also used to clear all the programmed selection for the program play.
- ⑪ **◀◀/SLOW- button (29, 38)**
Pressing this button during playback reverses playback rapidly (except MP3 disc).
Pressing this button while a DVD VIDEO disc is paused reverses playback slowly.
- ⑫ **TOP MENU button (33)**
Displays the top menu of a DVD AUDIO disc or the title menu of a DVD VIDEO disc on the TV screen.
- ⑬ **CURSOR (▲ Up, ▼ Down) - CH (+/-) buttons**
When the TV - DVD switch is set to DVD, these buttons are used to select an item from a menu or on-screen display, or to change the setting of an on-screen display item.
In this case, we call them "CURSOR ▲/▼" buttons in this manual.
When the TV - DVD switch is set to TV, they are used to select a TV channel.
- ⑭ **CHOICE button (57)**
Brings up the preference on-screen display on the TV screen.
- ⑮ **Infrared signal-emitting window (23)**
Point this window toward the remote sensor on the front panel when pressing buttons.
- ⑯ **TV STANDBY/ON ⏻/⏻ button (24)**
Turns the TV on or off (standby).
- ⑰ **TV - DVD switch (14, 24, 32)**
When setting this switch to "TV"; the numeric, cursor and TV/VIDEO - CANCEL buttons are used to control your TV.
When setting it to "DVD"; these buttons are used to control the unit.
- ⑱ **DVD STANDBY/ON ⏻/⏻ button (26)**
Turns the unit on or off (standby).
- ⑲ **RETURN button (33-34)**
Returns to the previous menu (for Video CD).
- ⑳ **TV/VIDEO - CANCEL button (24, 32)**
Switches the TV input mode when the TV - DVD switch is set to TV.
Cancels the last selection of the program when the TV - DVD switch is set to DVD.
- ㉑ **VFP button (48)**
Pressing this button brings up the VFP (Video Fine Processor) window in which you can select or adjust the picture character.
- ㉒ **AUDIO - S.FREQ button (47, 53)**
Selects the audio (for DVD AUDIO/DVD VIDEO/Video CD).
By pressing this button for more than one second during playback, the current sampling frequency is shown in the display window for a while.
- ㉓ **ZOOM +/- buttons (39)**
Zooms in or out the picture (for DVD VIDEO/Video CD).
- ㉔ **▶▶/NEXT button (30, 35, 54)**
Skips forward a chapter, title, group or track. Also used for the page selection of a menu screen (for DVD VIDEO/DVD AUDIO/Video CD).
Holding down this button during playback advances playback rapidly (except MP3 disc).
- ㉕ **⏸/STROBE button (29, 38, 54)**
Pauses playback. Also, used to display nine continuous still pictures (STROBE function).
Pressing this button while paused advances the still picture frame-by-frame.
- ㉖ **▶/SELECT button (28, 33)**
Starts playback. Also used as a SELECT button for PBC of Video CDs.
- ㉗ **▶▶/SLOW+ button (29, 38)**
Pressing this button during playback advances playback rapidly (except MP3 disc).
Pressing this button while a DVD VIDEO or Video CD disc is paused advances playback slowly.
- ㉘ **MENU button (33)**
Displays a DVD menu on the TV screen.
- ㉙ **ENTER button (11)**
Executes the selected item in a menu or on-screen display.
- ㉚ **CURSOR (◀ Left, ▶ Right) - VOL (+/-) buttons**
When the TV - DVD switch is set to DVD, these buttons are used to select an item from a menu or on-screen display, or to change the setting of an on-screen display item.
In this case, we call them "CURSOR ◀▶" buttons in this manual.
When the TV - DVD switch is set to TV, they are used to change the TV audio volume.
- ㉛ **ON SCREEN button (11)**
Brings up an appropriate on-screen display for controlling advanced functions for the current disc on the TV screen.

Rear panel

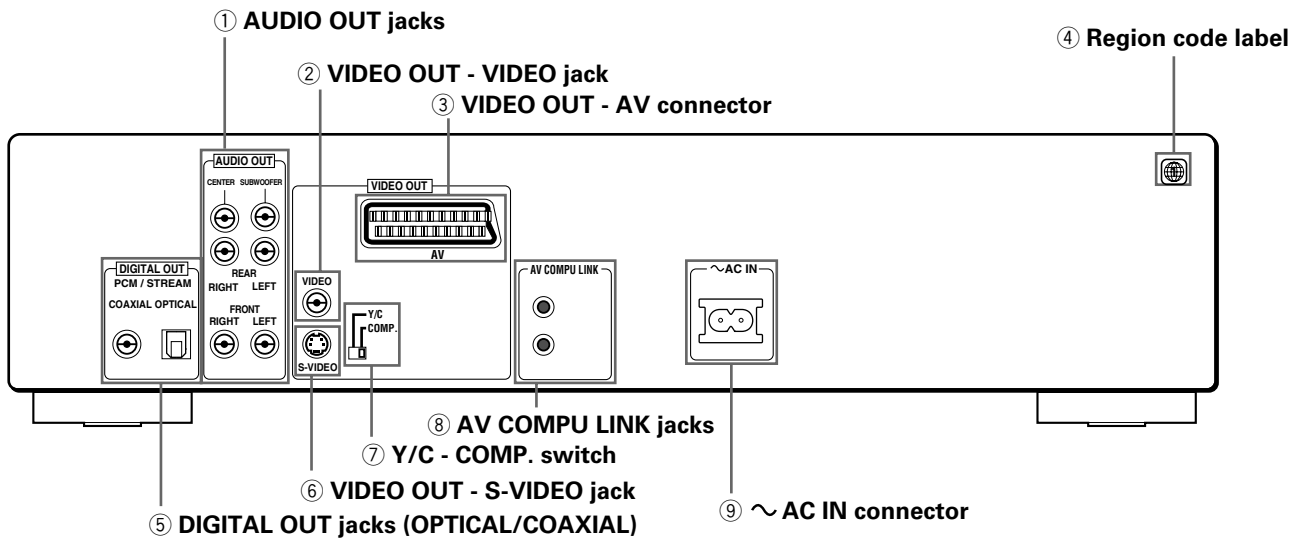













- | | |
|---|---|
| <p>1 AUDIO OUT jacks (17, 19, 20, 21)
Outputs the multichannel signals of a DVD AUDIO disc recorded by the linear PCM multichannel format or a DVD VIDEO disc recorded by the Dolby Digital surround, DTS or MPEG Multichannel format. FRONT jacks also output stereo analog audio signals.</p> <p>2 VIDEO OUT - VIDEO jack (17)
Outputs a composite video signal.
Note that, to use this jack, the Y/C - COMP. switch must be set to "COMP."</p> <p>3 VIDEO OUT - AV connector (18)
This standard 21-pin SCART connector outputs video and audio signals. It handles the composite, Y/C (S-video) and RGB video signals. The Y/C - COMP. switch must be set correctly according to the video signal used.</p> <p>4 Region code label (15)
Indicates the region code of the unit.</p> | <p>5 DIGITAL OUT jacks (OPTICAL/COAXIAL) (21)
Outputs digital audio signals. You must select the signal type correctly according to the external device connected to via the Preference display. Both the OPTICAL and COAXIAL connectors are provided.</p> <p>6 VIDEO OUT - S-VIDEO jack (17)
Outputs an S-video signal.
Note that, to use this jack, the Y/C - COMP. switch must be set to "Y/C".</p> <p>7 Y/C - COMP. switch (17, 18)
This selector must be set correctly according to the video signal type to be used. If you used any signal from the VIDEO OUT - VIDEO jack, or composite or RGB signal port in the VIDEO OUT - AV connector, set it to "COMP." If you use the VIDEO OUT - S-VIDEO jack or Y/C signal port in the VIDEO OUT - AV connector, set it to "Y/C".</p> <p>8 AV COMPU LINK jacks
These jacks are provided for use in the future. They are currently not used.</p> <p>9 ~ AC IN connector (22)
Connects to the wall outlet using the supplied AC power cord.</p> |
|---|---|

Operational Principles

On-screen displays

You can set preferences and perform advanced playback functions via various on-screen displays, including the Opening, Preference, Speaker setting, Parental Lock and Control displays.

Basic operations of on-screen displays

- You can move  using the CURSOR /// buttons to select items you want to work with.
- With an item like  you can change the setting by using the CURSOR / buttons when  is on the item.
-  - type item works when you place  on the item and press ENTER.
- In the message box, the operation to be performed is displayed according to the item pointed by .
- Numbers are entered using the numeric buttons.
- Some functions become effective by pressing ENTER after specifying necessary entries.

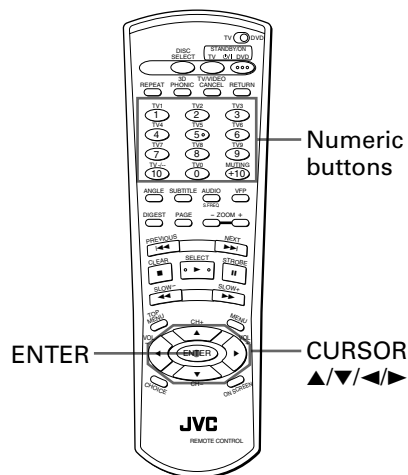

Preliminary knowledge

Opening display

An opening display appears automatically (without pressing any button) in some conditions.

One of the displays shown on the right appears when a disc is set and stopped. For a disc that does not contain any picture (such as an Audio CD), the opening display does not disappear after starting playback.



(for DVD AUDIO)



(for DVD VIDEO)



(for Audio CD)

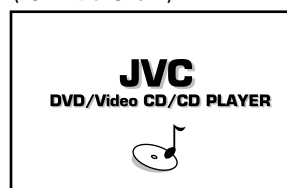



(for Video CD)



PREFERENCE (1, 2) and SPK.SETTING (speaker setting) displays (see page 57)

You can set preferences via these displays.

- To bring up the PREFERENCE 1/PREFERENCE 2/ SPK.SETTING display
 - When a DVD VIDEO disc is set and stopped or no disc is inserted, press CHOICE.
 - To select the display, move  to the desired tab using the CURSOR /  buttons.

(PREFERENCE1)

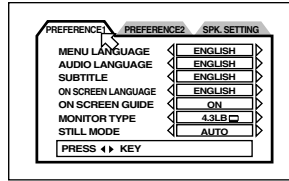

(PREFERENCE2)

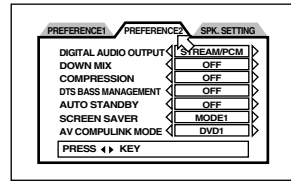

(SPK. SETTING)

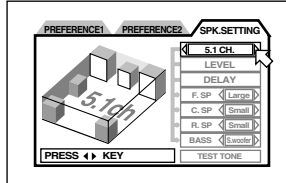

PARENTAL LOCK display (see page 64)

You can set the Parental Lock from this display.

- To bring up the PARENTAL LOCK display

When no disc is inserted or a DVD VIDEO disc is stopped, press ENTER while holding down .

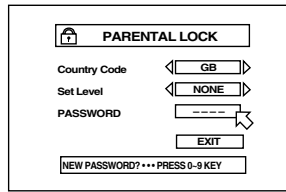

DVD CONTROL (for DVD VIDEO) display

You can select and set various functions for DVD VIDEO playback from this display. This display is available only during DVD VIDEO playback.

- To bring up the DVD VIDEO CONTROL display

During DVD VIDEO playback, press ON SCREEN.

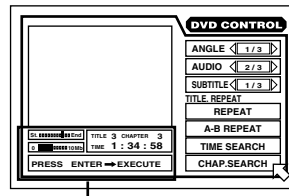

Current relative position of the title (St: start,End: end)

Current title number

Current chapter number

Transmission rate

Elapsed time from the beginning of the current title

DVD CONTROL (for DVD AUDIO) display

You can select and set various functions for DVD AUDIO playback from the display. There are two types of DVD AUDIO CONTROL display. One is shown during playback of pictures together with audio, while the other is shown during playback of audio only or while stopped.

- To bring up the DVD AUDIO CONTROL display

Press ON SCREEN when a DVD AUDIO is inserted. One of the displays above appears according to the disc contents and the unit's status.

(During playback of pictures together with audio)

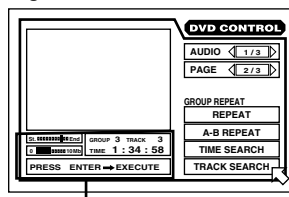

Current relative position of the title (St: start, End: end)

Current group number

Current track number

Transmission rate

Elapsed time from the beginning of the current title

(During playback audio only or while stopped)

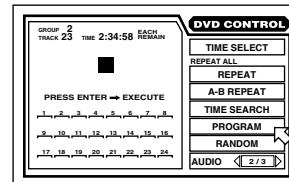

CD CONTROL display

You can select and set various functions for Audio CD playback from this display.

- **To bring up the CD CONTROL display**
Whenever an Audio CD is inserted, press ON SCREEN.

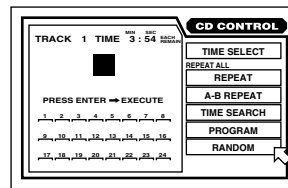

VCD CONTROL display

There are two types of VCD CONTROL display. The display shown on the right is available only during Video CD playback.

When a Video CD disc is stopped, a display similar to the CD CONTROL display appears.

- **To bring up the VCD CONTROL display**
Press ON SCREEN when a Video CD is inserted. The appropriate display appears according to the unit's status.

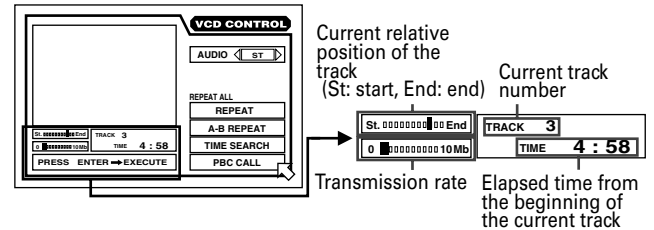

MP3 CONTROL display (see page 55)

The display shown on the right appears when a MP3 disc is set. You can select the desired Group to be played back.

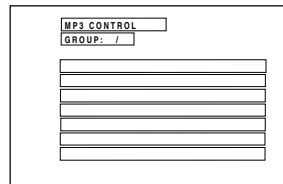

To prevent the monitor from burning out [SCREEN SAVER]

A television monitor screen may be burned out if a static picture is displayed for a long time. To prevent this, the unit automatically activates the screen saver function if a static picture, such as an on-screen display or menu, is displayed for over 5 minutes.

- Pressing any button on the unit or the remote control unit will release the screen saver function and return to the previous display.
- You can select one of several screen saver modes available (see page 61).
- The screen saver function is not activated during Audio CD/MP3 disc playback or after stopping Audio CD/MP3 disc playback.

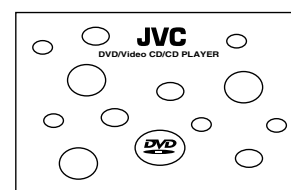

On-screen guide icons

During DVD VIDEO playback, you may see icons displayed over the picture. These have the following meanings.



: Displayed at the beginning of a scene recorded from multiple angles. (See page 44.)



: Displayed at the beginning of a scene recorded with multiple audio languages. (See page 47.)



: Displayed at the beginning of a scene recorded with multiple subtitle languages. (See page 46.)

You can set the unit not to display on-screen icons above via the preference settings described on page 58.

About invalid operation icon

When you press a button, if the unit does not accept its operation, appears on your television screen. Operations are occasionally unacceptable even if is not displayed.

Note that some operations may not be accepted. For example, some discs may not allow rapid advance/reverse or slow-motion playback.

How to use numeric buttons



The function of the numeric buttons differs depending on the setting of the TV - DVD switch. When setting it to TV, the buttons are used to select a TV channel (see pages 24 and 25). When setting it to DVD, the buttons are used to select a disc, select a track/title/group or enter a disc time or chapter number.

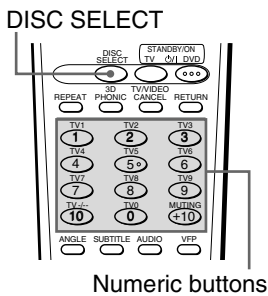

To select a disc

Press the DISC SELECT button, followed by the appropriate numeric button (1 through 7) within 5 seconds.

To select a track/title/group number

- **To select a number between 1 and 10**
Press the corresponding button for the number.
- **To select a number higher than 10**
Use the +10 button.

Examples:

To select 13 +10 → 3
To select 34 +10 → +10 → +10 → 4
To select 40 +10 → +10 → +10 → 10

To enter a time or chapter number

The method for entering a time for Time search or chapter number for Chapter search is different from above. See the corresponding sections in this manual for the details.

* There is another method for selecting a Track or Group of an MP3 disc. See the appropriate section.

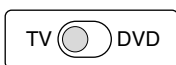

To select a TV channel

Press the corresponding numeric buttons. See page 24 and 25 for details.

About discs

Playable disc types

Playable and non-playable disc types are as follows:

Playable discs

DVD AUDIO 	DVD VIDEO 	Video CD 	Audio CD 
--	--	--	---

The DVD Logo is a trademark.

- CD-R and CD-RW discs recorded with the Audio CD format and CD-R discs recorded with the Audio CD, Video CD and MP3 format can be played back, though some discs may not be played back because of the disc characteristics or recording condition.
- DVD VIDEO players and DVD VIDEO discs have their own Region Code numbers. This unit only can play back DVD VIDEO discs whose Region Code numbers include "2".

Examples of playable DVD VIDEO discs:



This unit accommodates the PAL system.

Non-playable discs

DVD-ROM, DVD-RAM, DVD-R, DVD-RW, CD-ROM, PHOTO CD, CD-EXTRA, CD-G, CD-TEXT

- Playing back discs listed as "Non-playable discs" above may generate noise and damage speakers.
- This unit can play back audio recorded in CD-G, CD-EXTRA and CD-TEXT discs.

Audio formats

There are some formats of audio recorded on discs as shown below. The associated indicator lights up in the display window when playing back a disc.

Indicator	Audio format
LPCM	Linear PCM*
MPEG	MPEG Multichannel
DOLBY DIGITAL	Dolby Digital
DTS	DTS (Digital Theater Systems)

* When playing back a DVD AUDIO disc recorded by MLP (Meridian Lossless Packing; a lossless audio compression system that can completely recreate the PCM signal), the signal is recognized as the linear PCM signal, however, no indicator lights up in the display window.

Note that, with some formats and/or depending on the unit's "DIGITAL AUDIO OUTPUT" setting, digital audio signals are not always output from the unit's DIGITAL output jacks as are recorded on the disc. See "DIGITAL AUDIO OUTPUT" on page 59 for details.

Disc structure

A DVD VIDEO disc is comprised of "titles" and each title may be divided into some "chapters". For example, if a DVD VIDEO disc contains some movies, each movie may have its own title number, and each movie may be divided into some chapters. In a DVD VIDEO KARAOKE disc, each song usually has its own title number and does not have chapters. A DVD AUDIO disc is comprised of "groups", and each group is comprised of "tracks". Some DVD AUDIO discs also contain a "bonus group" that can be played back by entering the "key number" (a kind of password). Usually the contents of a "bonus group" are not opened to the public. Note that most DVD AUDIO discs include other information in addition to audio, such as still pictures, movies and text. An Audio CD or Video CD is simply comprised of "tracks."

(Example: DVD VIDEO disc)

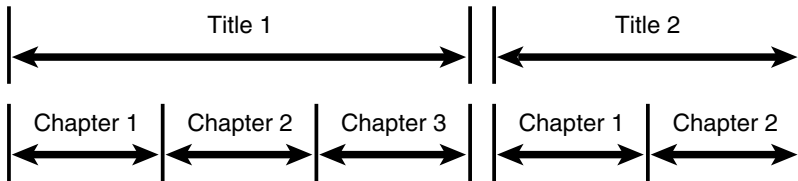

(Example: DVD AUDIO disc)

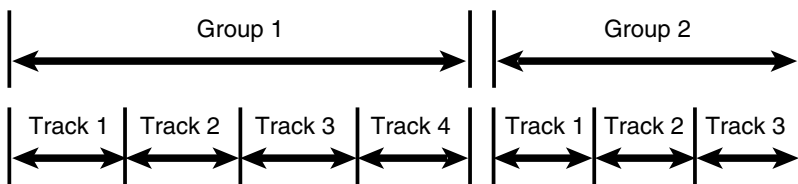

(Example: Audio CD/Video CD)

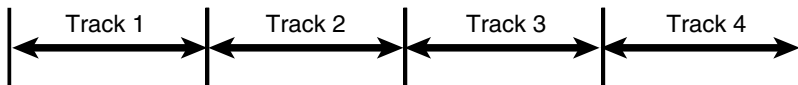

Connections

*In the following description, "TV" may be substituted with "monitor" or "projector."

*Before using the unit, you have to connect the unit to a TV and/or amplifier.

Before making any connections

- Do not connect the AC power cord until all other connections have been made.
- Since different components often have different terminal names, carefully read the instructions supplied with the component you are going to connect.

To connect to a conventional TV

You can enjoy playback by simply connecting the unit to a TV. To improve audio sound quality, connect the AUDIO OUT jacks to your separate audio equipment. (See the following pages.)

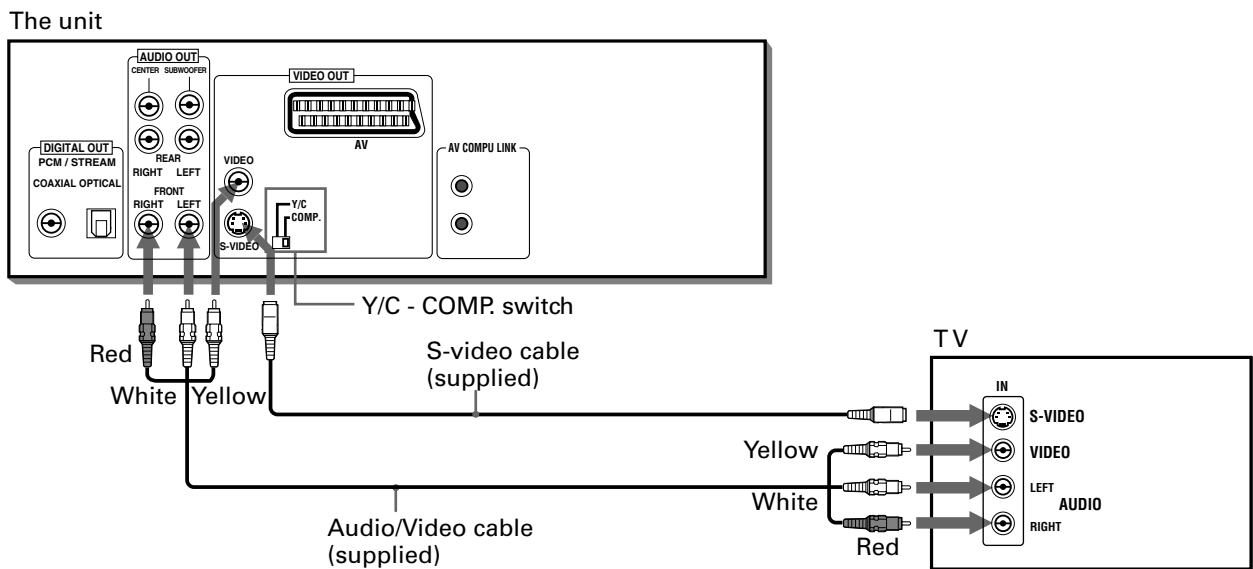

Connect the unit to a TV equipped with stereo audio input and video input jacks using the supplied audio/video cables.

- If your TV has a monaural audio input instead of stereo, you need to use an optional audio cable which converts stereo audio output to monaural.
- If your TV has an S-video input, you can get better picture quality by connecting it with the S-VIDEO output of the unit using the S-video cable in addition to the (standard) video connection. Note that, to use the VIDEO jacks, the Y/C - COMP. switch must be set to "COMP." and to use the S-VIDEO jacks, the Y/C - COMP. switch must be set to "Y/C".

NOTES

- Connect the unit to a PAL TV or multi-scan TV.
- When making the audio connection using the FRONT (LEFT and RIGHT) jacks, set "DOWN MIX" in "PREFERENCE 2" to "Lo/Ro" and the Speaker setting in "SPK. SETTING" to "2 CH." (see pages 60 and 62).
- Connect VIDEO OUT of the unit directly to the video input of your TV. Connecting VIDEO OUT of the unit to a TV via a VCR may cause a monitor problem when playing back a copy-protected disc.

To connect to a TV with the SCART connector

You can enjoy using the unit by simply connecting it to your television set with a 21-pin SCART cable. To hear audio sound with better quality, connect the audio output to your audio equipment.

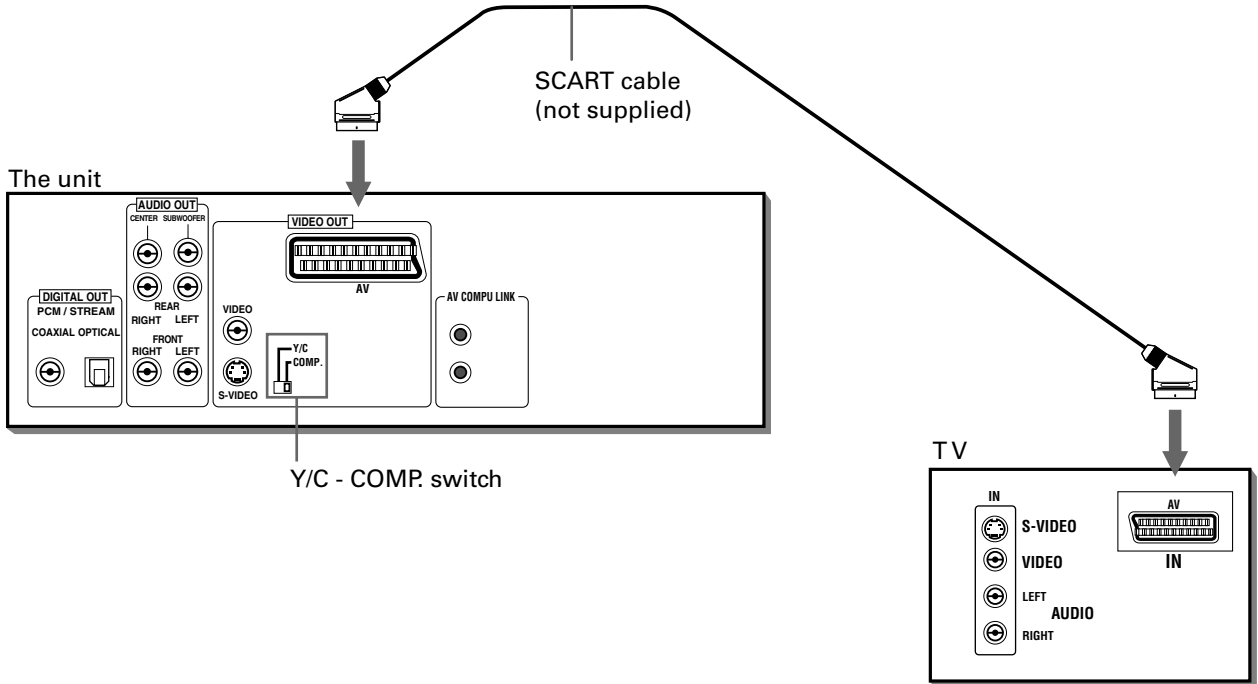

Set the Y/C - COMP. switch correctly according to your TV.

- If the TV only accommodates the composite video signal, set the switch to "COMP."
- If the TV accommodates the Y/C signals, set the switch to "Y/C" so that you can enjoy better-quality pictures.
- If the TV accommodates the RGB signals, set the switch to "COMP." so that you can enjoy better-quality pictures.

NOTES

- Connect the unit to a PAL TV or multi-scan TV.
- When making the audio connection using the SCART connector, set "DOWN MIX" on the "PREFERENCE 2" page of the preference display to "Lo/Ro" and the "SPK. SETTING" to "2 CH." (see pages 60 and 62).

To connect to an audio amplifier or receiver

You can enjoy high-quality audio by connecting the unit's audio output to your amplifier or receiver.

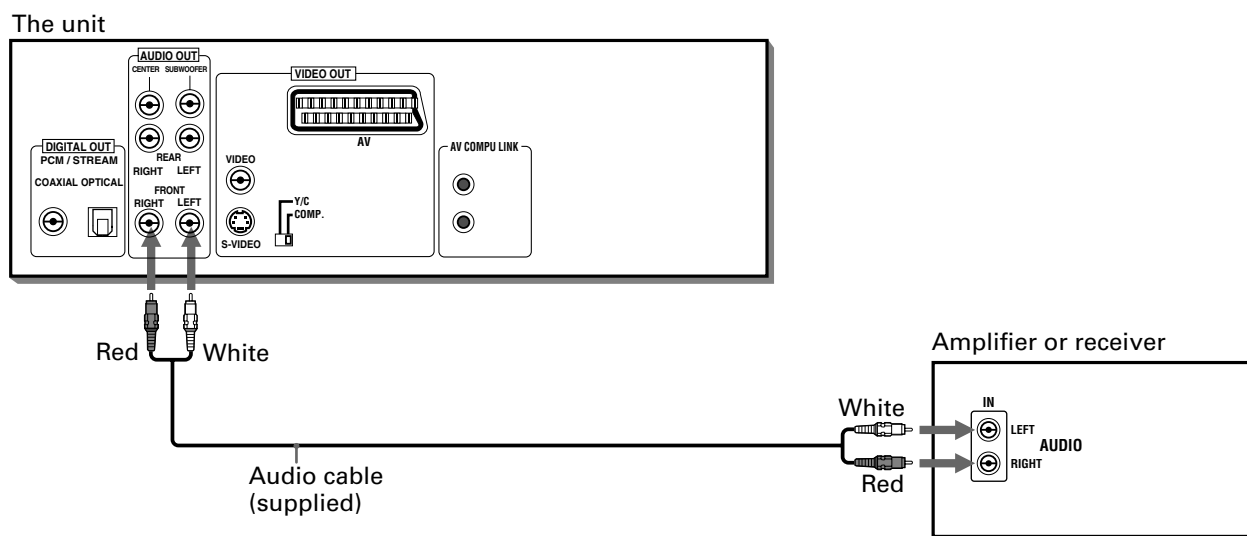

- Connect the unit's AUDIO OUT (FRONT LEFT/RIGHT) to any line-level inputs (such as AUX, DVD, CD, etc.) of an audio amplifier or receiver.

NOTE

- When using the unit with a stereo amplifier or receiver, make the "DOWN MIX" setting in "PREFERENCE 2" to "Lo/Ro" and the Speaker setting in "SPK. SETTING" to "2 CH." (see pages 60 and 62).

To connect to an amplifier/receiver equipped with 5.1-channel inputs

The unit supports the linear PCM multichannel format of DVD AUDIO and can feed multichannel audio output signals from the 6 analog AUDIO OUT jacks.

It is also equipped with the DTS, Dolby Digital and MPEG Multichannel decoders. So you can enjoy any type of the high quality surround sounds by connecting the unit to an amplifier/receiver equipped with the 5.1-channel inputs.

Connect the unit's analog AUDIO OUT jacks to the analog 5.1-channel inputs of an amplifier or receiver using the supplied audio cables.

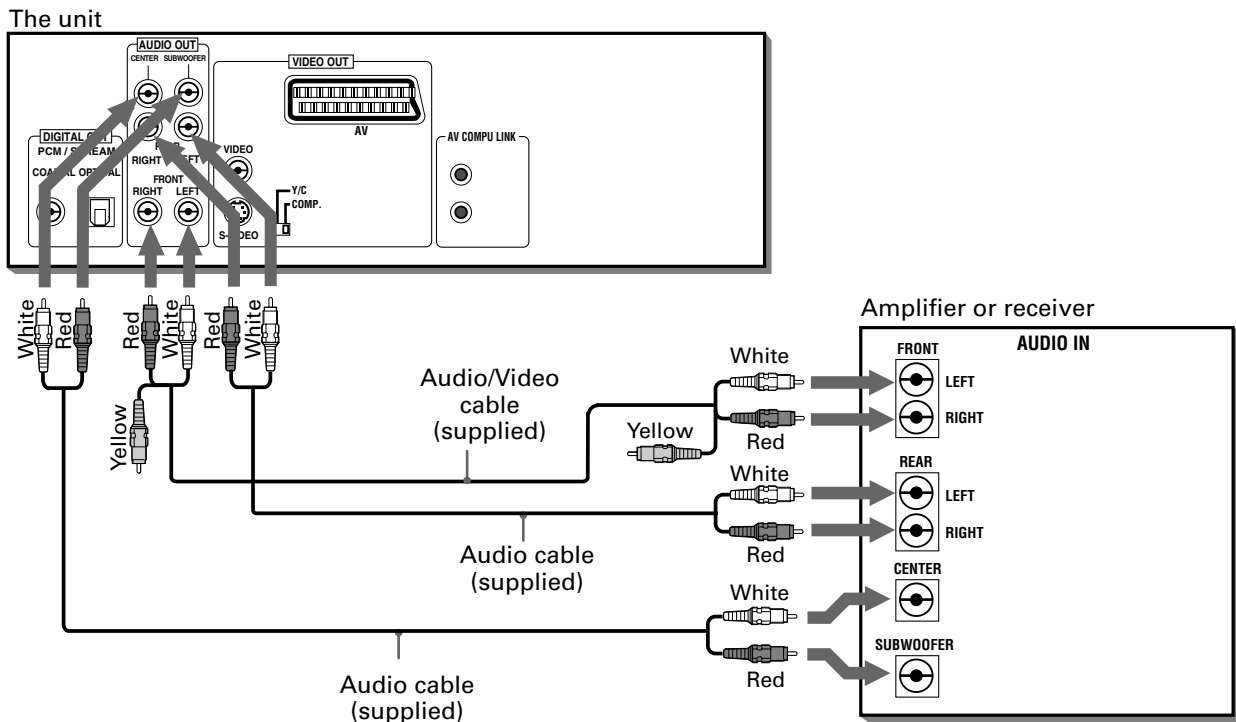

- Be sure to connect correctly between corresponding terminals. The order of the 5.1-channel terminals depend on units.

NOTE

- When using the 5.1-channel outputs of the unit, set the "DOWN MIX" in the "PREFERENCE 2" on-screen display to "OFF" and select "5.1 CH." or "EXPERT" in the "SPK.SETTING" on-screen display. If the "EXPERT" is selected, you can control the audio output balance of the speakers (see pages 60 and 62).

Getting started

To connect to audio equipment with a digital input

You can enhance the sound quality by connecting either of the unit's DIGITAL OUT jacks to the digital input of an amplifier, MD, etc. by using an optical or a coaxial digital cable (optional). The digital audio signal from a disc is directly transferred. If you connect the unit to a Dolby Digital, DTS or MPEG Multichannel decoder or an amplifier with a built-in decoder by using an optional digital cable, you can enjoy high-quality surround sound.

When you make the digital connection, we recommend also to make the analog connection, because, depending on discs, no signal may be output from the DIGITAL OUT.

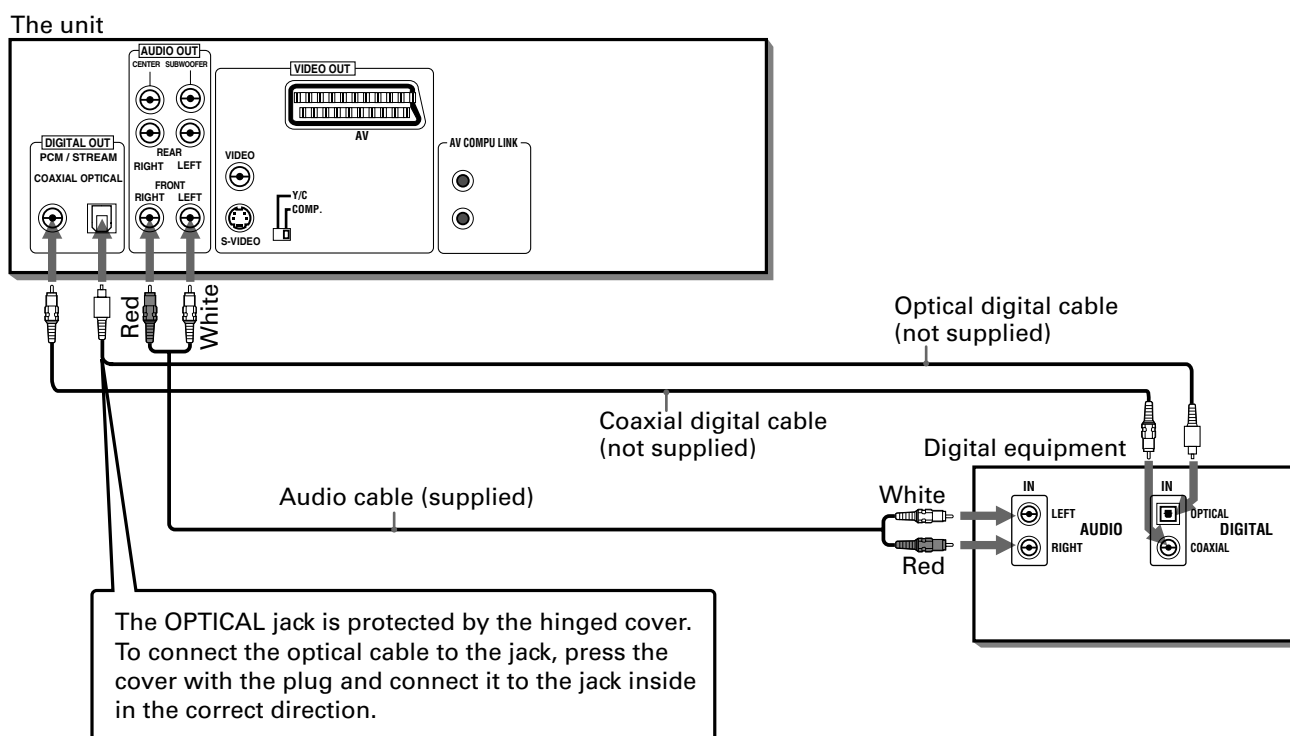

- For digital connection, connect the unit's DIGITAL output (OPTICAL or COAXIAL) to the digital input of an audio equipment using an optical or a coaxial digital cable.

NOTES

- When you connect the unit's DIGITAL OUT to digital audio equipment, before using, make the "DIGITAL AUDIO OUTPUT" setting in the "PREFERENCE 2" on-screen display correctly according to the connected audio equipment. If the "DIGITAL AUDIO OUTPUT" is not set correctly, loud noise may be generated from speakers, causing damage to them. See "DIGITAL AUDIO OUTPUT" on page 59.
- When you connect the unit's DIGITAL output to a Dolby Digital or DTS decoder (or amplifier with a built-in decoder) to enjoy surround sound, the unit's "COMPRESSION" setting in the "PREFERENCE 2" on-screen display and all settings in the "SPK. SETTING" display are invalid. Make appropriate surround audio settings by the decoder.

To connect the power cord

When all the audio/video connections have been made, insert the smaller plug of the supplied AC power cord to the unit's ~ AC IN connector, then insert the other end to the wall outlet. Make sure that plugs are inserted firmly. The STANDBY/ON indicator lights and setup is completed.

Warning

- Disconnect the power cord if you are not going to use the unit for a long time.
- Disconnect the power cord before cleaning the unit.
- Disconnect the power cord before moving the unit.
- Do not connect or disconnect the power cord with wet hands.
- Do not pull the power cord when disconnecting it, as this may damage the cord and cause fire, electric shock, or other accidents.

Caution

- Do not damage, alter, twist, or pull the power cord, as this may cause fire, electric shock, or other accidents.
- To prevent any accidents or damages caused by an unsuitable AC power cord, only use the supplied power cord. If the cord is damaged, contact a dealer and get the new power cord.
- Do not put anything heavy, or the unit, on the power cord, as this may cause fire, electric shock, or other accidents.

Using the remote control unit

Using the remote control, you can operate not only all the functions of the unit but also basic functions of your TV.

To install batteries in the remote control unit

The battery compartment is located on the back of the remote control unit.

1 Press down on the point shown by the arrow at the top of the compartment cover, and pull up the cover to open the compartment.

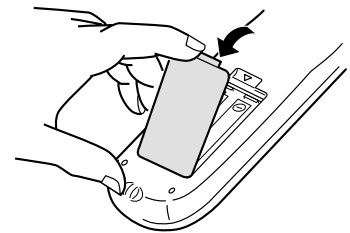

2 Place the two accessory R6P (SUM-3)/AA(15F) batteries in the remote control according to the polarity markings (“+” and “-”) inside the compartment and on the batteries.

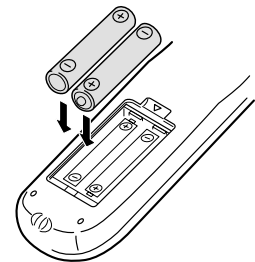

3 Place the cover over the compartment, and press down lightly.

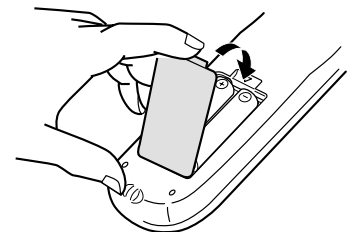

- The batteries will last about six months with normal use. If the functions of the remote control become erratic, replace the batteries. See next page for more information.

Precautions for the safe use of batteries

Observe the following precautions for the safe use of batteries. If they are used improperly their life will be shortened, they may burst or their contents may leak.

Precaution

- Remove the batteries from the remote control if it is not going to be used for a long period of time.
- Remove dead batteries and dispose of them properly.
- Never leave dead batteries lying around, take them apart, mix them with other refuse, or throw them into an incinerator.
- Never touch liquid that has leaked out of a battery.
- Do not mix new and old batteries, or batteries of different types, when replacing them.

Remote sensor

- Operate the remote control unit while pointing it toward the remote sensor on the unit.
- The remote control unit can be used within a range of about 5 meters from the remote sensor. If you operate the remote control unit from a diagonal position, controllable distance may be shorter.

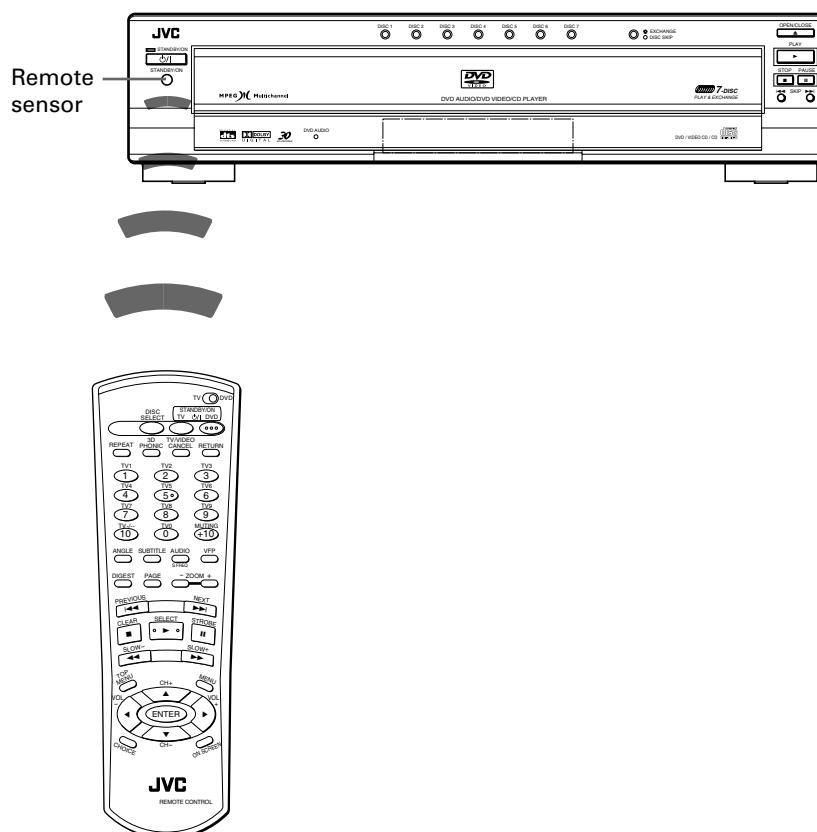

NOTE

- If the remote sensor on the unit is exposed to the sunshine or strong light, you may not be able to control the unit from the remote control unit.

To use the remote control unit for TV operation

You can operate your TV from the remote control unit.

Setting the remote control signal for operating your TV.

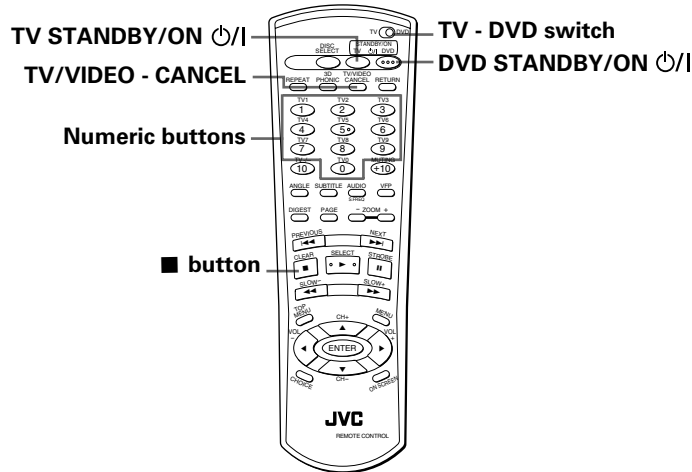

Getting started

- 1 Holding down TV/VIDEO - CANCEL, enter the manufacturer code of your TV listed below by using the numeric buttons (0 to 9).
Do not release TV/VIDEO - CANCEL. Keep holding it until the next step is completed.

Example:

To enter the manufacturer code "01": Press "0" then "1".

- 2 Press ■ while holding down TV/VIDEO - CANCEL.
- 3 Try to operate your TV by pressing TV STANDBY/ON. If your TV turns on or off, you have successfully set the control signal.

Manufacturer code list

No.	Manufacturer
01	JVC
02	PHILIPS/CCE/MAGNAVOX
03	mitsubishi
04	PANASONIC
05	RCA
06	SHARP
07	SONY
08	TOSHIBA
09	ZENITH
10	PHILCO/HITACHI
11	PANASONIC
12	SAMSUNG
13	SANYO/SEARS
14	TOSHIBA





No.	Manufacturer
15	GRADIENTE
16	SANYO
17	PHILCO/DAEWOO
18	LG (GOLDSTAR)
19	GRUNDIG
20	NEC/GRADIENTE
21	PHILCO
22	BEIJING/NOBLEX
23	JVC (ONWA)
24	JVC (ONWA)
25	JVC (ONWA)
26	THOMSON
27	FERGUSON
28	ITT

No.	Manufacturer
29	MIVAR
30	FINLUX
31	NOKIA
32	FUNAI
33	SAMSUNG
34	SAMSUNG/PEONY/CHANGHONG
35	SAMSUNG
36	AIWA
37	DAEWOO
38	JINXING/PEONY
39	PEONY
40	KONKA
41	TCL

The following buttons can be used for operating the TV:

To use the CURSOR (CH-, CH+, VOL-, VOL+), TV/VIDEO - CANCEL and numeric buttons for TV control, set the TV - DVD switch to "TV".

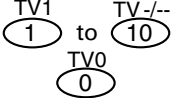

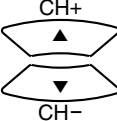
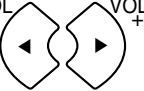
	<p>Turns the TV on or off.</p>
	<p>Switches the TV input mode between TV and VIDEO.</p>
	<p>Selects the TV channels directly. *For some TVs, pressing "+10" functions as the "100+," while "10" functions as the ENTER button if your TV requires pressing the ENTER button after selecting a channel number.</p>
	<p>Mutes the TV sound.</p>
	<p>Changes the TV channels.</p>
	<p>Adjusts the TV volume.</p>

NOTES

- The remote control unit is initially set operating a JVC TV.
- If there is more than one code listed for the manufacturer of your TV, try them one by one until you succeed.

Basic operations

In the following description, the buttons on the remote control unit are mainly used, however, you may use the corresponding buttons on the front panel of the unit if available.

Turning on/off the unit

Press DVD STANDBY/ON $\phi/|$ on the remote control unit or press STANDBY/ON $\phi/|$ on the front panel. The STANDBY/ON indicator, which illuminates in red during the standby mode, lights in green, while each DISC indicator (1 through 7) shows the current status of whether a disc is set or not in the corresponding tray.

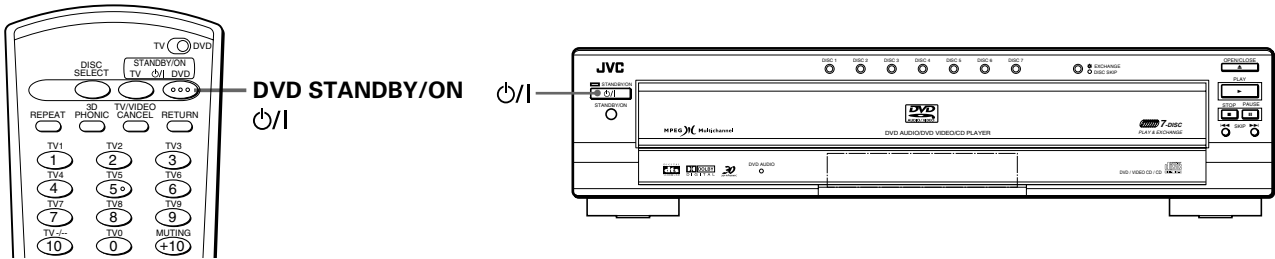

Hints

- The first time you turn on the unit after connecting the power cord, the DISC indicators are illuminated until the unit detects that no disc is set in the corresponding tray. Once detecting the status, the unit memorizes it unless you unplug the power cord, so the DISC indicators show the status of corresponding trays correctly.
- You can directly turn on the unit by pressing the \blacktriangleright , DISC (1 through 7) or \blacktriangle (OPEN/CLOSE) button while the unit is on standby, without pressing the DVD STANDBY/ON $\phi/|$ on the remote control unit or STANDBY/ON $\phi/|$ on the front panel. The behavior of the unit after pressing these buttons while the unit is on standby is the same as pressing them while the power is on. See the following description in which the unit is assumed that the power is on when starting operations.

NOTE

- Even if you press the DVD STANDBY/ON $\phi/|$ or STANDBY/ON $\phi/|$ button to turn off the unit, the unit is not disconnected from the AC power source as long as it is connected to the wall outlet. This state is called the standby mode. In this state, the unit consumes a very small amount of power.

Inserting and removing discs

Up to 7 discs can be set on the disc tray carousel.

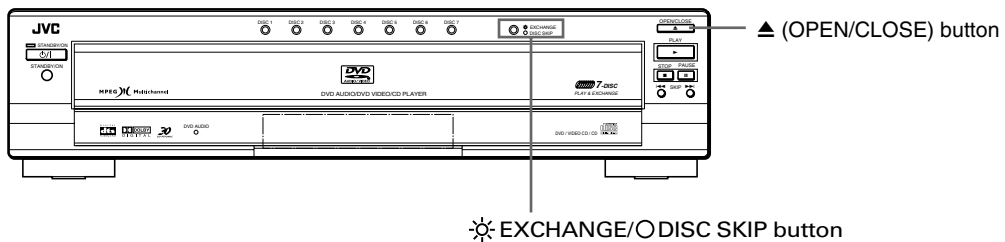

1 Press \blacktriangle (OPEN/CLOSE) on the front panel.

The carousel opens and you can access to two of seven trays.

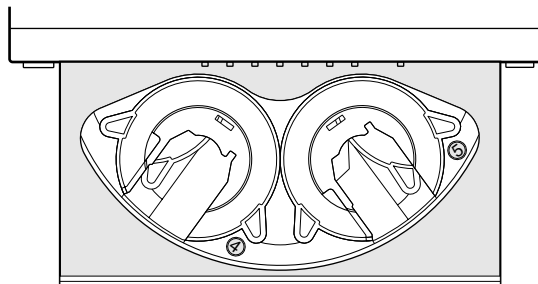

Hints

- From the second time on, the carousel opens with the previously played disc on the left-front tray.

2 Press EXCHANGE/ DISC SKIP to select accessible trays if required.

Each press of the button rotates the carousel clockwise by an amount for accessing the next two trays.

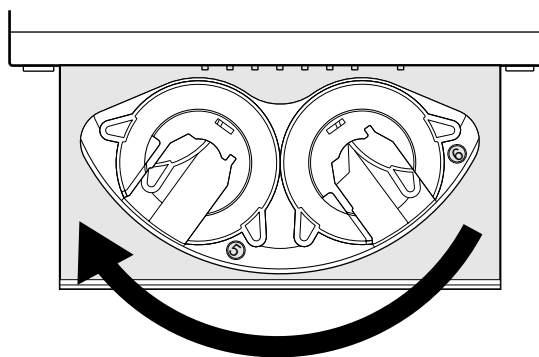

3 Place one or two discs in the tray(s).

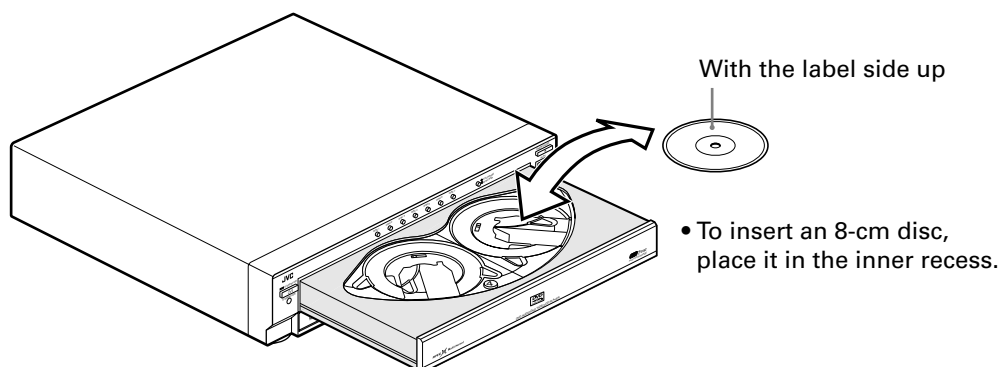

4 Repeat steps 2 and 3 if you wish to set one or more discs to other trays.

5 Press (OPEN/CLOSE).

The carousel closes.

The disc set in the front left tray when the carousel closes is loaded for playback. If no disc is set in the front left tray when the carousel closes, the unit rotates the carousel clockwise until it finds a disc for loading. If no disc is set at all in the carousel, "NO DISC" appears in the display window.

When a disc is loaded, the unit reads the information of the disc and the appropriate opening display according to the disc type appears on the TV screen (see page 11).

NOTES

- Do not set a non-playable disc. For details about playable and non-playable disc types, see page 15.
- When placing a disc in the tray, be sure to position the disc inside the recess. Otherwise, the disc may be damaged when the tray is closed, or the disc may not be removed from the unit.
- Do not use any stabilizer when playing back a disc.
- With most DVD VIDEO discs, the unit starts playback automatically after inserting the disc and pauses at the menu screen.
- If you insert a DVD VIDEO disc whose region code does not match the unit, "REGION CODE ERROR!" is shown in the DVD opening display. For detail about the region code, see page 15.

Basic playback

Note that this section describes basic operations for playback of DVD VIDEO, DVD AUDIO, Audio CD and Video CD discs. For MP3 disc playback, see the independent chapter on and after page 54.

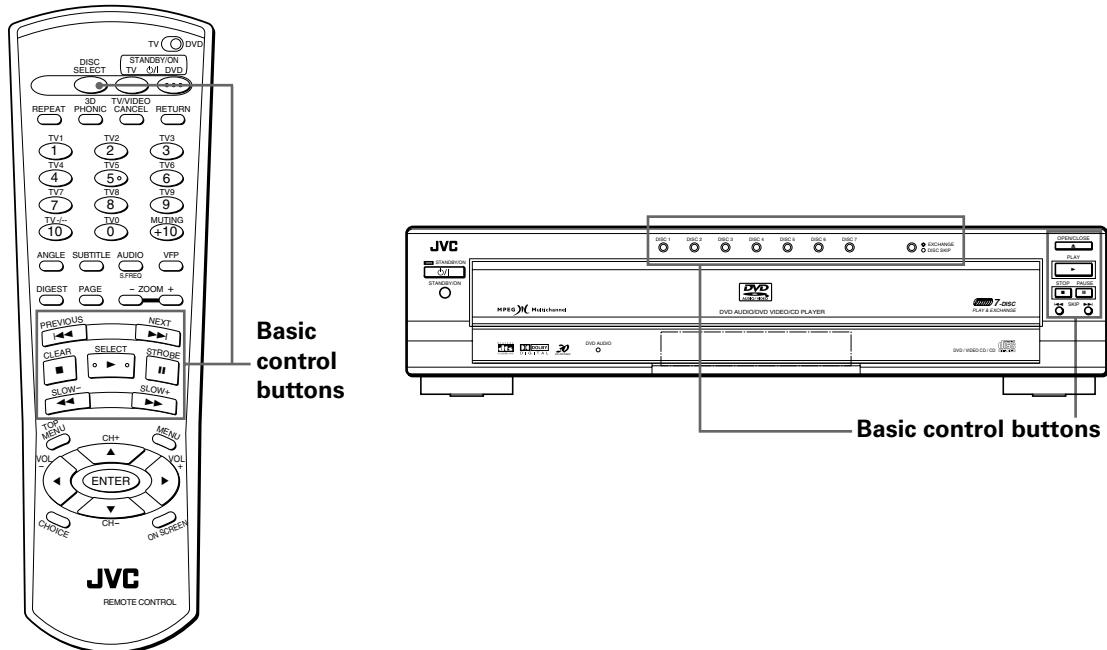

Basic control buttons

Basic control buttons

To start playback



Press ►.

or

Press a desired DISC (1 through 7) button on the front panel, or press DISC SELECT followed by a desired numeric (1 through 7) button on the remote control unit.

By the former operation (pressing ►), the unit starts playback from the disc loaded for playback after closing the carousel (see the previous page for details about which disc is loaded for playback).

By the latter operation (using DISC, or DISC SELECT + numeric buttons), the unit starts playback from the disc set in the specified tray. If no disc is set in the specified tray, the unit rotates the carousel clockwise until it finds a disc for playback.

Regardless of operations for starting playback, the unit plays all available discs sequentially until you stop playback. With some discs, which automatically goes to the menu screen and waits for the next instruction, the unit does not move to the next disc.

About DISC indicators (1 through 7)

Each DISC indicator shows the current status of the corresponding tray as follows.

- Illuminates if a disc is set in the corresponding tray.
- Flashes when the corresponding disc is being played back.
- Unlit if no disc is set in the corresponding tray.

NOTES

- Once a tray whose status is known by the unit becomes accessible when the carousel opens, the corresponding indicator lights regardless of whether or not a disc is set.
- When the resume point is memorized, pressing ► starts playback from that point instead of the beginning. See page 31.
- During playback, the display window shows the title/chapter or track number being played.
- With Video CD discs with PBC control or some DVD discs, the menu display may appear on the TV screen after starting playback. In such a case, select an item to be played back from the menu. Otherwise, the playback cannot go forward. For operation using a menu, see page 33.
- When a DVD disc is set in the front left tray, the unit usually starts playback automatically after closing the carousel and reading the disc contents.

To stop playback completely



Press ■.

The unit stops playback.



- If you press ▲ (OPEN/CLOSE) during playback, the unit stops playback and opens the tray carousel.

To stop playback temporarily



Press ⏸.

The unit pauses playback. To resume playback, press ▶.

To advance or reverse playback rapidly while monitoring



- During playback

Method 1 (from the remote control unit only)

Press ◀◀ or ▶▶.

Each press of ◀◀ or ▶▶ increases the playback speed. You can select the speed among 2x, 5x, 20x and 60x the normal speed.

Pressing ▶ returns the unit to normal playback.

Method 2

Hold down ◀◀ or ▶▶.

Holding down ▶▶ advances playback rapidly, while holding down ◀◀ reverses playback rapidly at 4 times the normal speed. Releasing the button returns the unit to normal playback.

To locate the beginning of the scene or song



- During playback

Press **⏮** or **⏭**.

Press **⏮** to locate the beginning of the current chapter, title, or track, and press **⏭** to locate the beginning of the next chapter, title, or track.

NOTE

- When you play a Video CD disc with the PBC function or a DVD VIDEO disc, the unit may locate a different place, but it will generally locate the beginning of the chapter, title or track.

Changing discs during playback [PLAY EXCHANGE]



You can open the carousel during playback and change discs that are not being played back.

- During playback (with the carousel closed)

In this condition, you can see the **⊛ EXCHANGE/○ DISC SKIP** indicator is illuminated in green.

1 Press **⊛ EXCHANGE/○ DISC SKIP**.

The carousel opens without interrupting playback, while the **⊛ EXCHANGE/○ DISC SKIP** indicator goes off. "EXCHANGE" is briefly shown in the display window.

2 Set, remove or change discs in the accessible trays.

3 To access to the other trays, press **⊛ EXCHANGE/○ DISC SKIP**.

Each press of the button rotates the carousel, however, the tray corresponding to the disc being played back is never accessible.

NOTES

- During the steps 2 and 3 above, only the **■**, **⏮**, **⏭** and **⏪**/**⏩** buttons are effective for the disc being played back.
- For details about functions of the **⊛ EXCHANGE/○ DISC SKIP** button, see the appropriate section on page 26.

Resuming playback

The unit can memorize the position on a disc where you interrupt playback, and resume playback from that position later.

To memorize the interrupted position



- During playback

Press ■, or press DVD STANDBY/ON on the remote control unit or STANDBY/ON on the front panel.

The unit memorizes the interrupted position.

“RESUME” appears in the display window for a few seconds.



- If you interrupt playback by pressing ■ and then turn off the power, the memory is not cleared.

To resume playback



- While the disc you interrupt playback last time is still loaded in the disc tray

Press ►.

The unit starts playback from the position where you interrupted playback last time.

“RESUME PLAY” appears in the display window for a few seconds.

- **To clear the resume position memory**

Carry out one of the followings.

- * Open the carousel.
- * Press ■ while stopped.
- * Press any of the DISC buttons (1 through 7) on the front panel, or the DISC SELECT button followed by any of the 1 through 7 numeric buttons.

NOTES

- The resume function does not work with Audio CD and MP3 discs.
- In the case of a Video CD disc with PBC function, the unit may resume playback from a point slightly earlier or later than the resume point you stored.

Advanced operations

- Note that this section describes operations for playback of DVD VIDEO, DVD AUDIO, Audio CD and Video CD discs. For MP3 disc playback, see the independent chapter on and after page 54. But "Checking the sampling frequency" on page 53 is applied to MP3 discs.
- The following table shows the contents of this section together with effective disc types for each operation.

Function	DVD VIDEO	DVD AUDIO	Audio CD	Video CD	Page
Playing from a specific position on a disc					
To locate a desired scene from the DVD menu	yes	yes			33
To locate a desired scene from the menu of the Video CD with PBC				yes	33
To locate a desired selection using the numeric buttons	yes	yes	yes	yes	34
To locate a desired selection using \blacktriangleleft or \blacktriangleright	yes	yes	yes	yes	35
To specify a desired chapter/track from the on-screen display [CHAP. SEARCH/TRACK SEARCH]	yes	yes*			35
To locate a desired position in the current title or track [TIME SEARCH]	yes	yes	yes	yes	36
To locate a desired scene from the display [DIGEST]	yes			yes	37
Special picture playback					
To advance a still picture frame-by-frame	yes			yes	38
To display continuous still pictures [STROBE]	yes			yes	38
To playback in slow-motion [SLOW]	yes			yes	38
To zoom in/out [ZOOM]	yes			yes	39
Changing the playback order					
To playback in the desired order [PROGRAM]		yes	yes	yes	40
To playback in random order [RANDOM]		yes	yes	yes	41
Repeat playback					
To repeat the current selection or all tracks [REPEAT]	yes	yes	yes	yes	42
To repeat a desired part [A-B REPEAT]	yes	yes	yes	yes	43
Selecting a scene angle of DVD VIDEO					
To select a scene angle from the normal screen [ANGLE]	yes				44
To select a scene angle from the angle list display [ANGLE]	yes				45
Changing the language and sound					
To select the subtitle language [SUBTITLE]	yes	yes*			46
To change the audio language or sound [AUDIO]	yes	yes		yes	47
Miscellaneous functions					
To adjust the picture character [VFP]	yes	yes*		yes	48
To simulate surround sound [3D PHONIC]	yes				49
To check the disc time [TIME SELECT]		yes	yes	yes	50
To select a still picture on a DVD AUDIO disc [PAGE]		yes			51
To playback a bonus group of a DVD AUDIO disc		yes			52
Changing the brightness of the display window	yes	yes	yes	yes	52
Checking the sampling frequency	yes	yes	yes	yes	53

- In the table above, "yes*" shows that the corresponding function is effective to non-audio information (such as movies, still pictures and text data) if recorded on a DVD AUDIO disc.

NOTE



Make sure that the TV - DVD switch is set to "DVD" when using the CURSOR $\blacktriangle/\blacktriangledown/\blacktriangleleft/\blacktriangleright$, numeric and TV/VIDEO - CANCEL buttons for controlling the unit.

Playing from a specific position on a disc

You can play a disc from the selected track, title or chapter, or from the specified time.

To locate a desired scene from the DVD menu



DVD discs generally have their own menus which show the disc contents. These menus contain various items such as titles of a movie, names of songs, or artist information, and display them on the TV screen. You can locate a desired scene by using the menu.

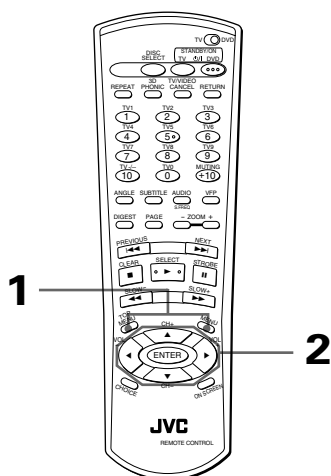

- Whenever a DVD disc is loaded
 - 1 Press TOP MENU or MENU.
The menu appears on the TV screen.



About menu

Normally, a DVD VIDEO disc which contains more than one title may have a "title" menu which lists the titles. Similarly, a DVD AUDIO disc which contains more than one group may have a "top" menu which lists the groups. In such a case, the menu appears on the TV screen by pressing the TOP MENU button. Some DVD discs may also have a different menu which appears by pressing the MENU button. See the instructions of each DVD disc for its particular menu.

Example:

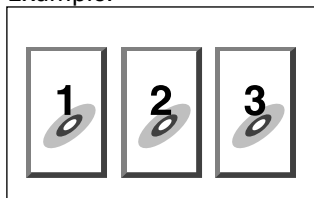

- 2 Use CURSOR ▲/▼/◀/▶ to select a desired item, then press ENTER.
The unit starts playback of the selected item.



- With some discs, you can also select items by entering the corresponding number using the numeric buttons, which may cause the unit to automatically start playback.

NOTES

- When appears on the TV screen by pressing TOP MENU in step 1:
The disc does not have a menu listing the titles or groups.
- When appears on the TV screen by pressing MENU in step 1:
The disc does not have a menu.
- The MENU button does not work while stopped.

To locate a desired scene from the menu of the Video CD with PBC



Some Video CD discs supports the PBC function. PBC is an abbreviation of "PlayBack Control." A Video CD disc recorded with PBC has its own menus, such as a list of the songs of the disc. You can locate a specific scene by using the menu.

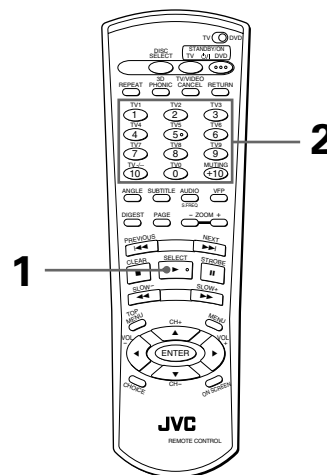

- When a Video CD disc with PBC is stopped

- 1 Press ►.

A disc menu appears on the TV screen (The PBC function is activated).

Example:

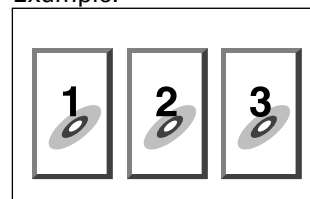

"PBC" is indicated in the display window on the front panel.

- 2 Use the numeric buttons to select the desired item.

- See page 14 for details about how to use the numeric buttons.

The unit starts playback of the selected item. You can return to the menu by pressing the RETURN button.

When "NEXT" or "PREVIOUS" appears on the TV screen, the unit generally works as follows:

- Pressing ►► advances to the next page.
- Pressing ◀◀ returns to the previous page.
- * The method of the operation is different depending on the disc.

Hints

- To activate the PBC function when a PBC-compatible Video CD disc is being played back without the PBC function, press ■ then press ►.
- You can also activate the PBC function using the on screen menu display as follows.
 - 1 Press ON SCREEN.
 - 2 Use CURSOR ▲/▼ to move ↖ to [PBC CALL], then press ENTER.
- If you want to playback a PBC-compatible Video CD disc without activating the PBC function, start playback by using the numeric buttons instead of the ►. See the next paragraph.

To locate a desired selection using the numeric buttons



You can locate the desired title or chapter (for DVD VIDEO), group or track (for DVD AUDIO), or track (for Audio CD/Video CD) from which the unit starts playback.

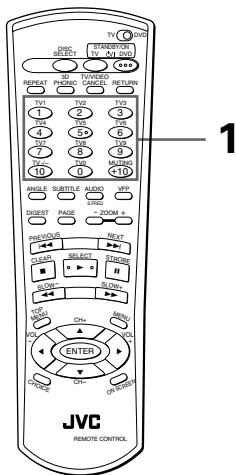

- For DVD VIDEO/DVD AUDIO/Audio CD: During playback or while stopped
- For Video CD: During playback without PBC function or while stopped

1 Use the numeric buttons to specify the number.

- * During DVD VIDEO/DVD AUDIO playback (except when a menu is shown), a chapter is specified.
- * While a DVD VIDEO/DVD AUDIO is stopped, a title is specified.
- * For an Audio CD or Video CD, a track is specified.

The unit starts playback from the beginning of the selection.

- See page 14 for details about how to use the numeric buttons.

Depending on the disc type and the unit status, what is specified differs.

Unit status	Disc type	What is specified
While stopped	DVD VIDEO	title or chapter(*1)
	DVD AUDIO	group or track(*2)
	Audio CD/ Video CD	track
During playback	DVD VIDEO	chapter
	DVD AUDIO	track
	Audio CD/ Video CD	track

*1 If a disc contains more than one title, a title is specified. If a disc contains only one title, a chapter is specified.

*2 If a disc contains more than one group, a group is specified. If a disc contains only one group, a track is specified.

The selected title, group or track number appears in the display window on the front panel.

Hints

- You can also see the selected number on the on-screen display.

NOTES

- During DVD VIDEO or DVD AUDIO playback, if a menu is shown on the TV screen, the numeric buttons may be used for selecting an item in the menu.
- When ⓪ appears on the TV screen: The title or track you have selected is not contained in the disc.
- This function does not work during Video CD playback with PBC function.

To locate a desired selection using

◀◀ or ▶▶



You can locate the beginning of a chapter (for DVD VIDEO) or track (for DVD AUDIO/Audio CD/Video CD) by using the ◀◀ or ▶▶.

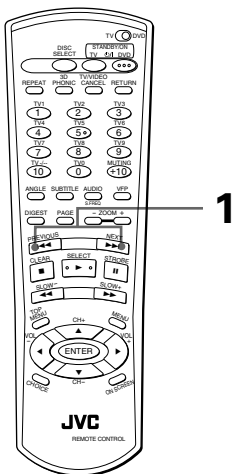

- For DVD VIDEO: During playback
- For DVD AUDIO/Audio CD: During playback or while stopped
- For Video CD: During playback without PBC function

1 Press ◀◀ or ▶▶.

With an DVD AUDIO, Audio CD or Video CD, pressing the button skips a track. With a DVD VIDEO disc, pressing the button skips a chapter or title depending on the disc configuration. The selection number appears in the display window on the front panel.

- To skip forward chapters/tracks, press ▶▶ as many times as required.
- To skip to the beginning of the current track/chapter, press ◀◀ once.
- To skip back chapters/tracks, press ◀◀ as many times required.

NOTES

- You can skip tracks within the current disc only.
- This function may not work with some DVD VIDEO discs.
- This function does not work during Video CD playback with PBC function.

To specify a desired chapter/track from the on-screen display [CHAP. SEARCH/ TRACK SEARCH]



When playing back pictures of a DVD VIDEO or DVD AUDIO disc, you can specify the chapter/track number to be played from the on-screen display.

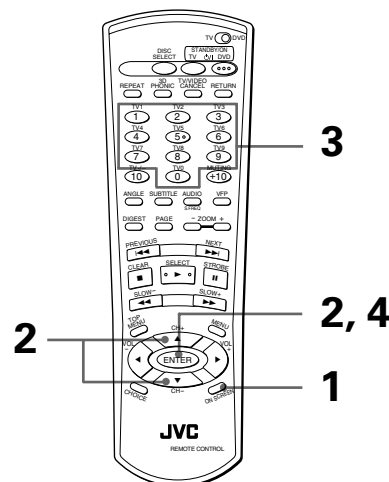

- During playback of pictures

1 Press ON SCREEN.

The on-screen display appears on the TV screen.

2 Use CURSOR ▲/▼ to move to [CHAP. SEARCH] or [TRACK SEARCH], then press ENTER.

"GO TO CHAPTER=" or "GO TO TRACK=" appears in the message area.

The color of [CHAP. SEARCH] or [TRACK SEARCH] changes.

(for DVD VIDEO)

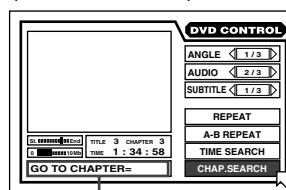

Message area

(for DVD AUDIO)

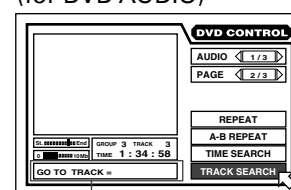

Message area

3 Use the numeric buttons (0 to 9) to enter the desired chapter/track number.

Example:

To select chapter number 8:
Press "8" → ENTER.

To select chapter number 37:
Press "3" → "7" → ENTER.

The specified number appears in the message area.

4 Press ENTER.

The unit starts playback from the selected chapter.

Hints

- The “10” and “+10” buttons are not used in this function.

NOTES

- You can also locate a desired chapter directly by specifying the chapter or track number using the numeric buttons during playback (except when a menu is shown). See page 34.
- When the chapter or track number is incorrect in step 3: Overwrite the incorrect number with the correct number.
- When  is displayed on the TV screen in step 4: The chapter or track you have selected is not contained in the disc, or chapter/track search does not work on the disc.
- To return to the regular display: Press ON SCREEN.
- You cannot use this function with a DVD AUDIO disc that does not contain any picture.

To locate a desired position in the current title or track [TIME SEARCH]



You can play a disc from the desired position by specifying the elapsed time from the beginning of the current title (for DVD VIDEO), the current group (for DVD AUDIO) or the disc (for Audio CD/Video CD) using the TIME SEARCH function.

Note that some DVD VIDEO discs do not contain time information, and the TIME SEARCH function cannot be used.

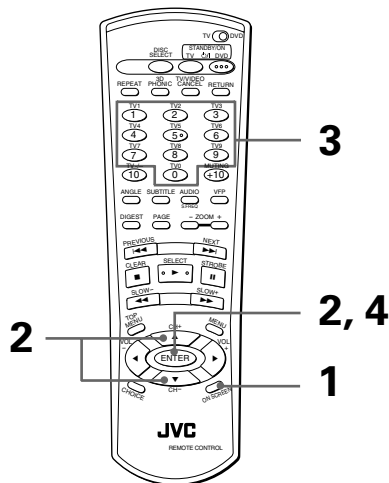

- For DVD VIDEO: During playback
- For DVD AUDIO/Audio CD: During playback or while stopped
- For Video CD: During playback without PBC function or while stopped

1 Press ON SCREEN.

The on-screen display appears on the TV screen.

2 Use CURSOR  to move  to [TIME SEARCH], then press ENTER.

“GO TO” appears in the message area. The color of [TIME SEARCH] changes.

3 Use the numeric buttons (0 to 9) to enter the time.

The specified time appears in the message area.

4 Press ENTER.

The unit starts playback from the specified time.

• **Screen example**

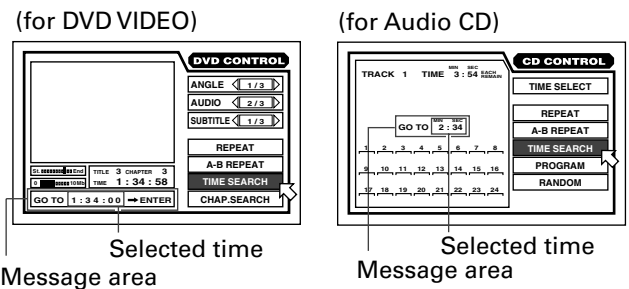

Hints

- “10” and “+10” buttons are not used with this function.
- You can specify the time in hour/minute/second format for DVD VIDEO/DVD AUDIO discs, and in minute/second format for Audio and Video CD discs.

• **Example (for DVD AUDIO/DVD VIDEO)**

To playback from 2(H):34(M):00(S)

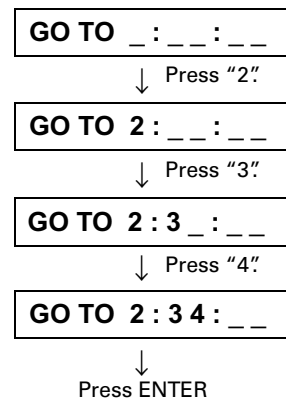

You do not have to press “0” to enter the trailing zeros (for the last two digits in the example above). Of course, it is possible to enter them.

When you make a mistake

Move the cursor to the incorrect value, then press the correct button to re-select the value.

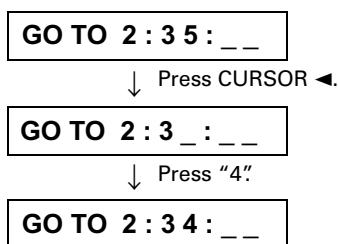

NOTES

- While a DVD AUDIO disc is stopped, you can specify the elapsed time from the beginning of group 1.
- When appears on the TV screen in step 2: The time you have selected is not contained on the disc, or the Time search function does not work on the disc. Also note that the Time search function does not work during Video CD playback with the PBC function.
- To return to the regular display: Press ON SCREEN.
- The TIME SEARCH function cannot be used during program playback.

To locate a desired scene from the display [DIGEST]



The unit can display the opening scene of each title or chapter on a DVD VIDEO or each track of a Video CD. You can select a desired scene from those displayed on the TV screen.

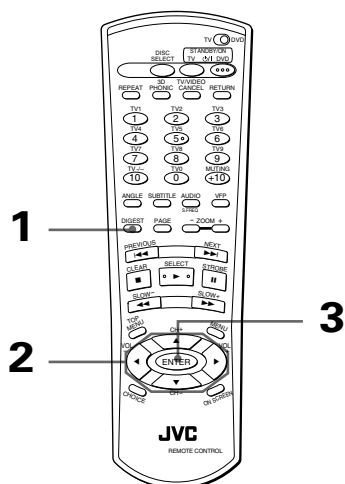

- For DVD VIDEO: While stopped or during playback
- For Video CD: While stopped or during playback without PBC function

1 Press DIGEST.

Up to nine opening scenes are displayed.



- While a DVD VIDEO disc is stopped: The opening scene of each title appears on the TV screen.
- During DVD VIDEO disc playback: The opening scene of each chapter in the current title appears on the TV screen.
- When a Video CD disc is loaded: The opening scene of each track appears on the TV screen.

2 Use CURSOR ▲/▼/◀/▶ to move to select the desired scene.

If there are more than 9 scenes, the digest screen will have more than one page. In this case, pressing advances to the next page, while pressing returns to the previous page.



Selected scene

Hints

- When the lower right scene is selected, pressing CURSOR advances to the next page if available. Similarly, when the upper left scene is selected, pressing CURSOR returns to the previous page (if available).
- Depending on discs, it may take some time until all scenes of the current page appear on the TV screen. If you want to turn the page, you do not have to wait to press or until all scenes appear.

3 Press ENTER.

The unit starts playback from the selected scene.

NOTE

- With some discs, depending on the contents, it may take some time until all the scenes appear on the screen.

Special picture playback

The unit provides special picture playback functions including Frame-by-frame, Strobe, Slow-motion and Zoom.

To advance a still picture frame-by-frame

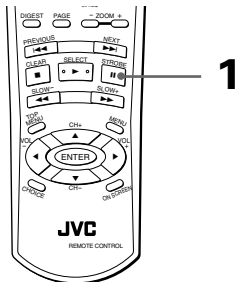

- While paused (still)

1 Press **II**.

Each time you press **II**, the still picture advances to the next frame.

Pressing **▶** returns to normal playback.

To display continuous still pictures [STROBE]

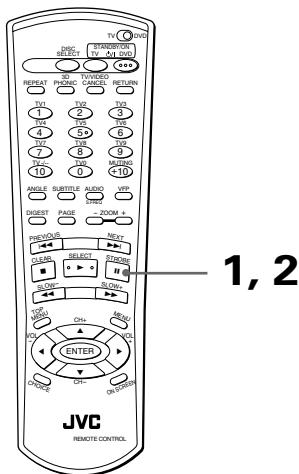

- During playback

1 At the point you want to view as continuous photographs, press **II**.

The unit pauses playback.

2 Press and hold **II** for more than 1 second.

Nine continuous still pictures appear on the TV screen.

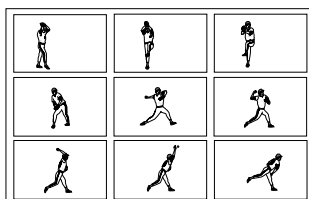

Hints

- Pressing **II** when the nine still pictures are shown will advance pictures frame by frame.
- **To cancel strobe play**
Press and hold **II** for more than 1 second.

NOTES

- If you press and hold **II** for more than 1 second during playback, nine still pictures also appear but they advance in normal playback speed.
- The sound is muted during STROBE playback.

To playback in slow-motion [SLOW]

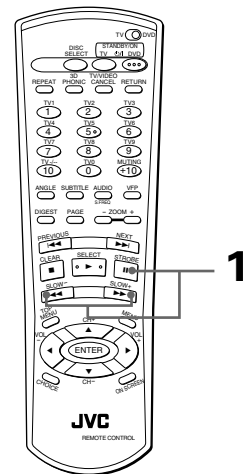

- During playback

1 Press **II**, then use **◀◀/▶▶**.

To play forward slow-motion, press **▶▶**, and to play reverse slow-motion (for DVD VIDEO discs only), press **◀◀**. First, the unit plays the slowest speed, and each time you press the button, the playback speed increases.

- **To return to normal playback**
Press **▶**.
- **To pause slow-motion playback**
Press **II**.

NOTES

- The sound is muted during slow-motion playback.
- Reverse slow-motion playback is not possible for a Video CD.

To zoom in/out [ZOOM]

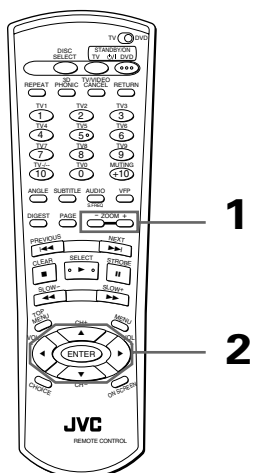

- During playback or while paused

1 Press ZOOM + or -.

The unit zooms in by pressing ZOOM + or zooms out by pressing ZOOM -. Each time you press ZOOM +, the magnification is doubled (up to x 1024). Each time you press ZOOM -, the magnification is halved (down to x 1/8).

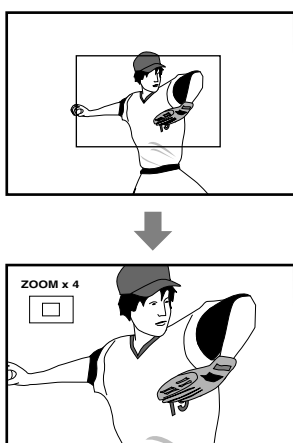

At the top-left of the screen, the information for the current magnification appears, as well as the zoomed-in position of the scene that can be moved by operating the next step.

2 Use CURSOR ▲/▼/◀/▶ to move the zoomed position.

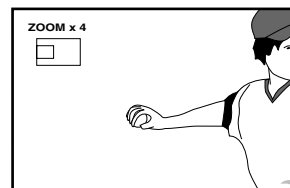

- To return to normal playback
Press ENTER.

NOTE

- While zoomed, the picture may look coarse.

Changing the playback order

You can play tracks on a DVD AUDIO, Audio CD or Video CD disc currently loaded in the desired order or in random order using the Program or Random playback function.

Note that you cannot use these functions among multiple discs.

To playback in the desired order [PROGRAM]



By programming tracks, you can play up to 24 tracks in any order. You may program the same track more than once.

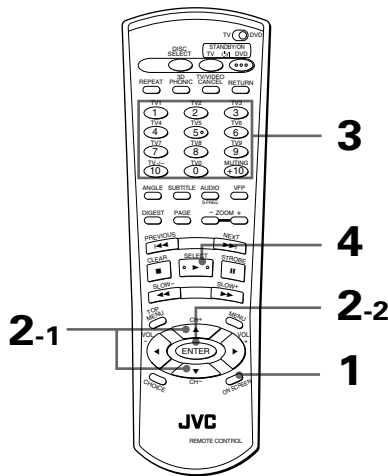

- While stopped

1 Press ON SCREEN.

The on-screen display appears on the TV screen.

2 Use CURSOR ▲/▼ to move to [PROGRAM] and press ENTER.

The color of [PROGRAM] changes.

(for DVD AUDIO)

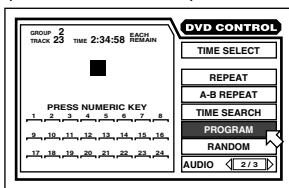

(for Audio CD)

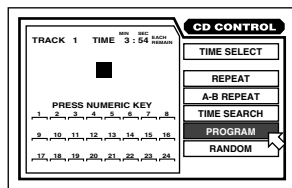

(for Video CD)

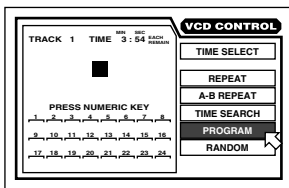

The program table appears on the on-screen display.

The "PROGRAM" indicator lights in the display window on the front panel.

3a (for Audio CD/Video CD)

Specify tracks on the disc loaded in the desired order using the numeric buttons.

See page 14 for details about how to use the numeric buttons.

3b (for DVD AUDIO)

Specify selections in the desired order by group and track numbers using the numeric buttons.

- For each program step, using the numeric buttons, specify a group first, then specify a track.

For example, to specify "track 14 in group 2", Press 2 → +10 → 4

Up to 24 tracks can be programmed. You may select the same track more than once.

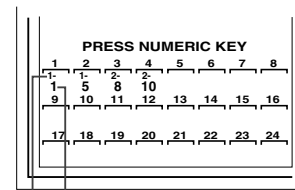

Selected track number
Selected group number

- If you specify a wrong selection

Press TV/VIDEO - CANCEL button. The last selection programmed is erased.

- To clear the program

Press ■.

4 Press ► to start program play.

When all of the programmed tracks have finished playback, the unit stops but the program remains.

NOTES

- You cannot use the program playback function among discs set in the carousel. You can program only tracks on the disc currently loaded.
- During program playback, pressing ►► skip to the next selection of the program. Pressing ◀◀ returns to the beginning of the current selection.

To quit program playback

Press ENTER when points [PROGRAM]. [PROGRAM] returns to its original color. (When playing back a Video CD, you have to press ■ and then press ON SCREEN to bring up the on-screen display.)

To clear the program

While stopped and the on-screen display is shown on the TV screen, move to [PROGRAM] and then press ■. All the programmed tracks are erased. You can also clear the program by opening the carousel or changing the current disc.

Hints

- If you are going to program a track in the bonus group of a DVD AUDIO, the unit will ask you to enter the key number for the bonus group (see page 52).
- You can add tracks to the program during program playback of Audio CD.

To playback in random order [RANDOM]



You can play tracks on a disc in random order by using the Random function.

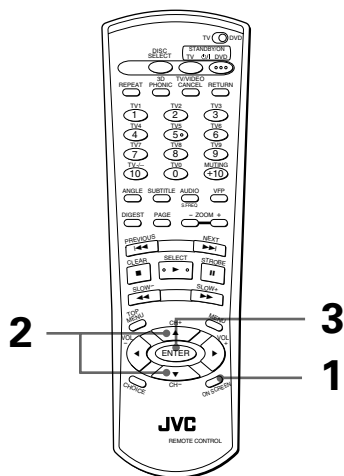

While stopped

1 Press ON SCREEN.

The on-screen display appears on the TV screen.

2 Use CURSOR ▲/▼ to move to [RANDOM].

(for DVD AUDIO)

(for Audio CD)

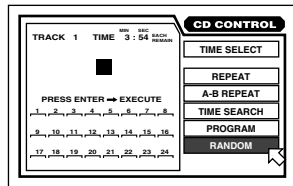
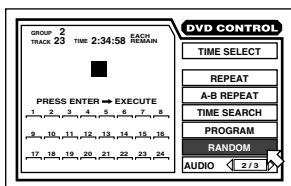

(for Video CD)

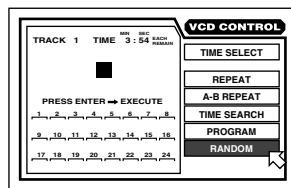

3 Press ENTER.

The color of [RANDOM] changes. The unit starts random playback. The "RANDOM" indicator appears in the display window on the front panel. After playing all tracks of the disc loaded, random playback ends.

Hints

- The same track will not be played back more than once during random play.
- During Audio CD playback, pressing ENTER when points [RANDOM] quits random mode and continues playback in the normal order.
- In the random playback mode with the DVD AUDIO, tracks in the bonus group are not played back (see page 52).
- **To quit random playback in the middle**
Press ■. The unit stops playback and quits the random playback mode. You can also clear the random mode by opening the carousel or changing the current disc.

NOTE

- Random playback is carried out only within the disc currently loaded.

Repeat playback

You can repeat playback of the current title or chapter (for DVD VIDEO), current group or track (for DVD AUDIO), or current or all tracks. You can also repeat playback of a desired part.
 Note that you cannot repeat playback of multiple discs.

To repeat the current selection or all tracks [REPEAT]



Method 1

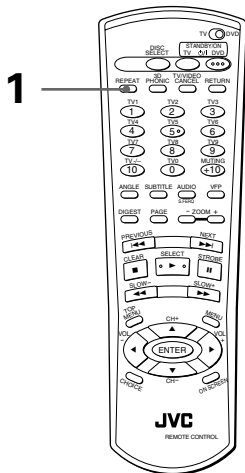

- For DVD AUDIO/DVD VIDEO: During playback
- For Audio CD/Video CD: In any condition except Video CD playback with PBC

1 Press REPEAT.

Each time you press REPEAT, the repeat mode toggles among All repeat, Repeat 1 and OFF. You can see the selected mode by icons in the display window on the front panel as below.

- : Repeats the current title for DVD VIDEO, current group for DVD AUDIO, or all tracks on the current disc for Audio CD/Video CD.
- : Repeats the current chapter for DVD VIDEO or the current track for DVD AUDIO, Audio CD/Video CD.

No indication:
 The repeat mode is off. However, note that the unit repeats playback of all discs set in the carousel endlessly unless there is any disc that automatically pauses at the menu.

(Display window)

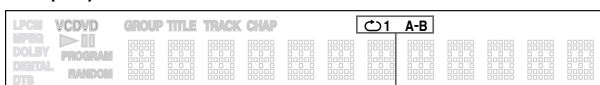

Repeat mode indicators

Method 2

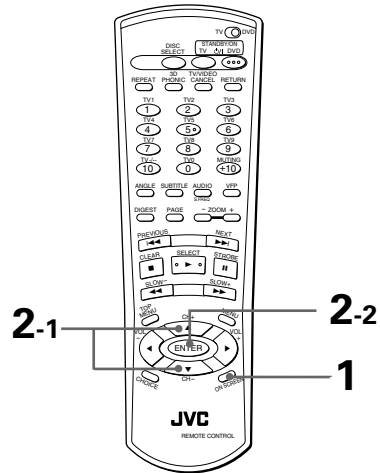

- For DVD AUDIO/DVD VIDEO: During playback
- For Audio CD/Video CD: In any condition except Video CD playback with PBC

1 Press ON SCREEN.

The on-screen display appears on the TV screen.

2 Use CURSOR ▲/▼ to move to [REPEAT], then press ENTER.

Each time you press ENTER, the repeat mode changes as follows depending on the disc type and unit's status:

- During DVD VIDEO playback

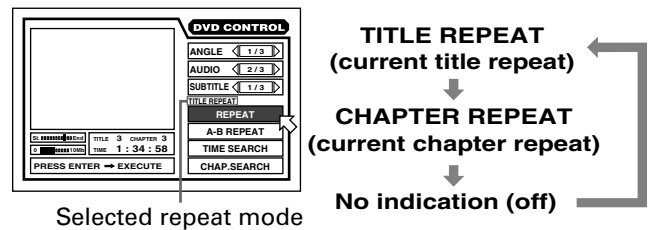

- for DVD AUDIO

The current track, or all tracks in the current group is/are played repeatedly.

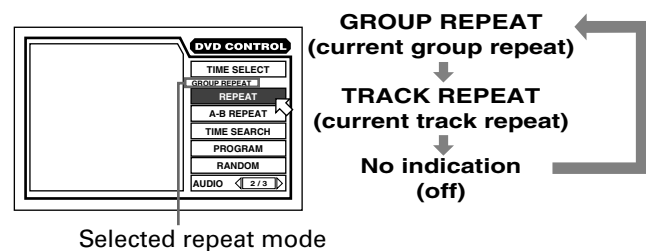

• **Audio CD/Video CD**

(for Audio CD)

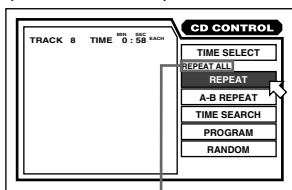

Selected repeat mode

(for Video CD)

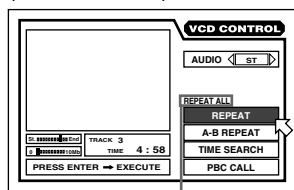

Selected repeat mode

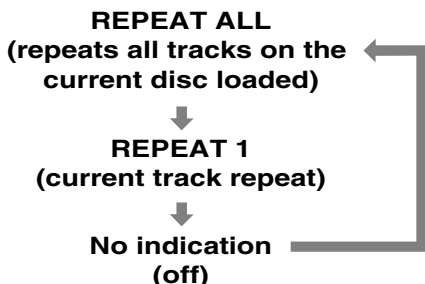

The selected mode is also shown on the on-screen display, however, it is shown in the different way from the display window. The following table shows the relation between them.

Disc type	Display window	On-screen display
DVD VIDEO	⏮	TITLE REPEAT
	⏮1	CHAPTER REPEAT
DVD AUDIO	⏮	GROUP REPEAT
	⏮1	TRACK REPEAT
Audio CD/ Video CD	⏮	REPEAT ALL
	⏮1	REPEAT 1

• **To stop repeat playback**

Press ■ .

When a DVD VIDEO disc is set, the unit stops playback and quits the repeat mode.

When a DVD AUDIO, Audio CD or Video CD disc is set, the unit stops playback but does not quit the repeat mode.

• **To quit repeat playback**

Perform one of the following:

- * Press REPEAT until the repeat mode indicator goes off in the display window.
- * When [REPEAT] points [REPEAT], press ENTER repeatedly until [REPEAT] returns to its original color.

You can also clear the repeat mode by opening the carousel or changing the current disc.

NOTES

- The repeat function can be applied only to the disc currently being played back. (Unlike the normal playback, the unit does not perform the endless playback of all available discs on the carousel.)
- When the program playback mode is active with a DVD AUDIO, Audio CD or Video CD, the repeat mode changes in the same manner (i.e. toggles among REPEAT ALL, REPEAT 1 and no indication).

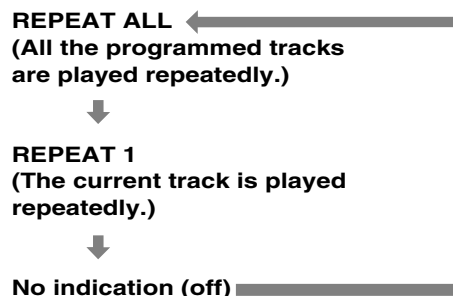

Note that, however, in the "REPEAT ALL" mode the unit repeats all the programmed tracks, instead of all tracks on the disc.

- If ⊘ appears when pressing ENTER in step 2 above during DVD VIDEO playback
You cannot repeat the title or chapter because of the disc contents.
- Repeat playback function cannot be used during Video CD playback with PBC function.
- To turn off the on-screen display
Press ON SCREEN.

To repeat a desired part [A-B REPEAT]



Advanced operations

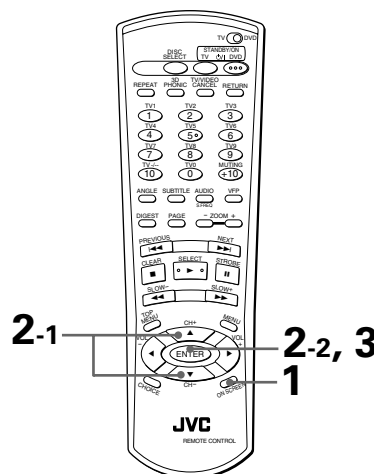

• During playback

- 1 Press ON SCREEN.
The on-screen display appears on the TV screen.
- 2 Use CURSOR ▲/▼ to move [REPEAT] to [A-B REPEAT], then press ENTER at the beginning of the part you want to repeat (point A).
The color of [A-B REPEAT] changes.

3 Press ENTER at the end of the part you want to repeat (point B).

The unit locates "A" and starts repeat playback between "A" and "B."

(for DVD AUDIO)

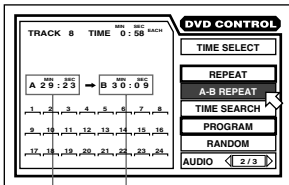

Point A Point B

(for DVD VIDEO)

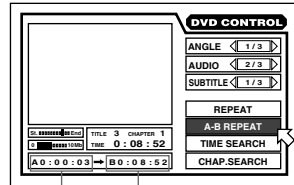

Point A Point B

(for Audio CD)

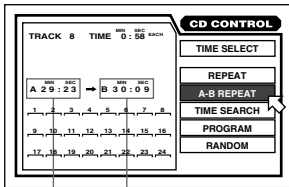

Point A Point B

(for Video CD)

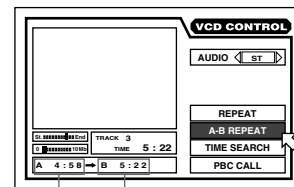

Point A Point B

• To quit A-B repeat playback

Press **■**. The unit stops playback and quits A-B repeat mode.

You can also clear the A-B repeat mode by opening the carousel or changing the current disc.



- During playback, pressing ENTER when is pointed at [A-B REPEAT] quits A-B repeat mode and continues playback.
- You can also quit A-B repeat mode by pressing **◀◀** or **▶▶**.

NOTES

- **Points A and B must be specified on the same track or chapter.**
After specifying point A, if you do not specify point B until the playback position moves to the next track/chapter, the unit quits the A-B repeat mode and the color of [A-B REPEAT] on the on-screen display returns to its original color.
- **To turn off on-screen display**
Press ON SCREEN.
- **If appears when pressing ENTER in step 2 during DVD VIDEO playback**
You cannot repeat the selected portion because of the disc contents.

Selecting a scene angle of DVD VIDEO

You can enjoy a variety of scene angles if the DVD VIDEO disc contains "multi-angle" parts, where multiple cameras were used to shoot the same scene from different angles.



- At the beginning of a "multi-angle" part, appears on the TV screen.

To select a scene angle from the normal screen [ANGLE]



From normal screen

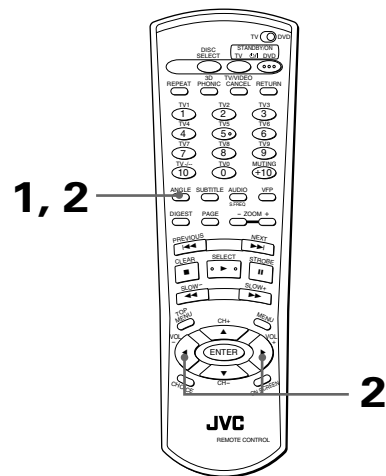

- During DVD VIDEO playback

1 Press ANGLE.

The Angle selection display appears on the TV screen.

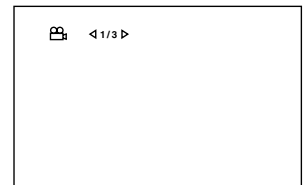

2 Use ANGLE or CURSOR to select the desired angle.

Each time you press ANGLE or CURSOR , the angle changes.

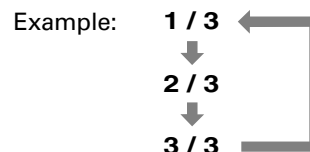

NOTES

- The Angle selection display will automatically disappear if you do not change the angle for several seconds.
- To turn off the Angle selection display manually, press ENTER.
- When  appears on the TV screen
The current scene is not recorded from multiple angles.

From on-screen display

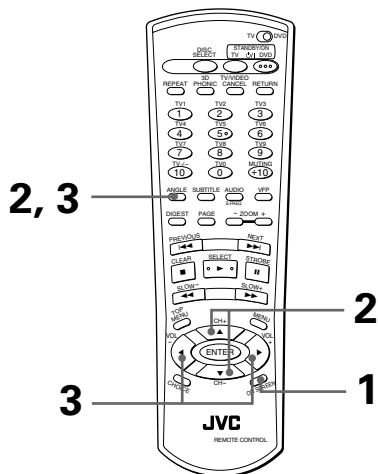

- During DVD VIDEO playback

1 Press ON SCREEN.

The on-screen display appears on the TV screen.

2 Use CURSOR ▲/▼ or ANGLE to move  to [ANGLE].

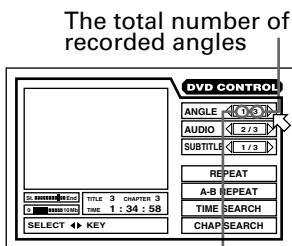

The total number of recorded angles

The current angle number

3 Use CURSOR ◀/▶ or ANGLE to select the desired angle number.

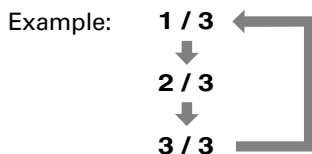

NOTES

- To turn off the on-screen display Press ON SCREEN.
- When  appears on the TV screen
The current scene is not recorded from multiple angles.

To select a scene angle from the angle list display [ANGLE]

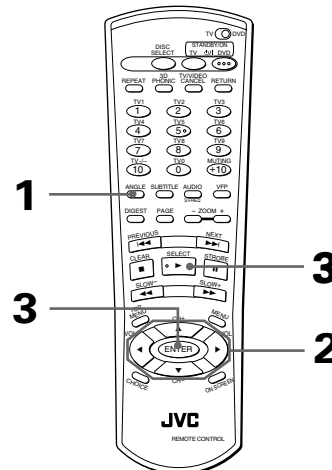

- During DVD VIDEO playback

1 Press and hold ANGLE for more than 1 second.

Up to nine camera angles recorded on a disc appear on the TV screen.

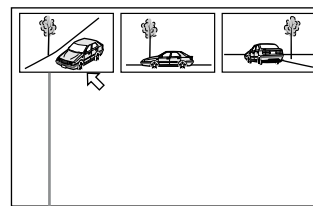

The selected camera angle

2 Use CURSOR ▲/▼/◀/▶ to select the desired angle.

3 Press ENTER or ▶.

The unit starts playback by the selected angle on the full-sized screen.

NOTES

- When  appears on the TV screen in step 1:
The current scene is not recorded from multiple angles.
- During the operation above, audio is muted.

Changing the language and sound

Some DVD VIDEO discs support more than one subtitle language and/or audio language/sound, while some DVD AUDIO discs support more than one audio language/sound.

You can select the desired one from them. Similarly, you can select audio channel(s) of a Video CD disc.

To select the subtitle language [SUBTITLE]



From normal screen

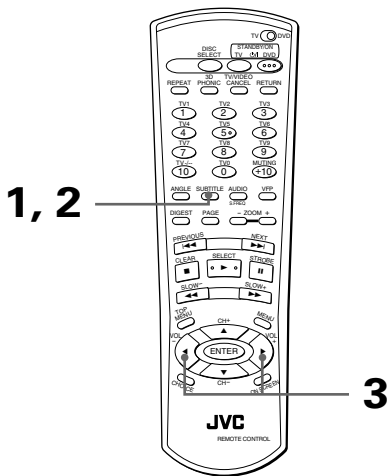

- During DVD VIDEO/DVD AUDIO playback

1 Press SUBTITLE.

The Subtitle selection display appears on the TV screen.

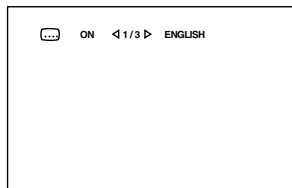

2 To turn the subtitle on and off, press SUBTITLE.

3 To select the desired subtitle language, use CURSOR ◀/▶.

Each time you press CURSOR ◀/▶, the subtitle language changes.

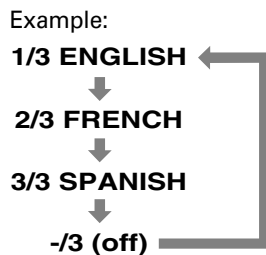

From on-screen display (DVD VIDEO only)

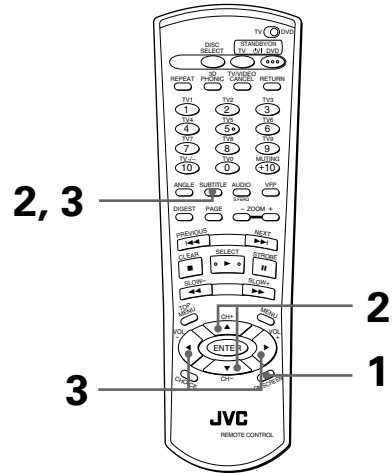

- During DVD VIDEO playback

1 Press ON SCREEN.

The on-screen display appears on the TV screen.

2 Use CURSOR ▲/▼ or SUBTITLE to move to [SUBTITLE].

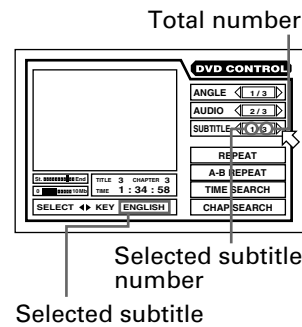

3 Use CURSOR ◀/▶ or SUBTITLE to select the desired subtitle.

Each time you press CURSOR ◀/▶ or SUBTITLE, the subtitle changes.

NOTES

- For DVD VIDEO, the selected language may be abbreviated on the TV screen. See "Appendix A: Table of languages and their abbreviations" at the end of this manual.
- The Subtitle selection display will automatically disappear if you do not change the subtitle for several seconds.
- To turn off the Subtitle selection display manually, press ENTER.
- To turn off the on-screen display: Press ON SCREEN.
- When appears on the TV screen: You cannot select the subtitle.

To change the audio language or sound [AUDIO]



By AUDIO selection, you can choose the audio language of movies or enjoy KARAOKE with or without the vocal.

From normal screen

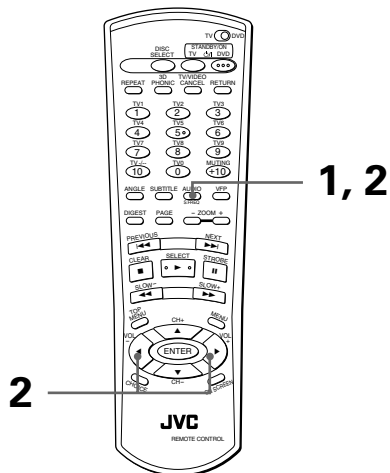

- During playback

1 Press AUDIO - S.FREQ.

The Audio selection display appears on the TV screen



2 Use AUDIO - S.FREQ or CURSOR <left>/<right> to select the desired audio.

From on-screen display

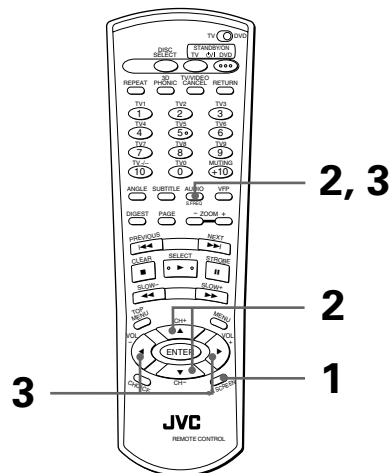

- During playback

1 Press ON SCREEN.

The on-screen display appears on the TV screen.

2 Use CURSOR <up>/<down> or AUDIO - S.FREQ to move <right> to [AUDIO].

(for DVD VIDEO)

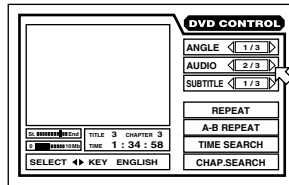

(for DVD AUDIO)

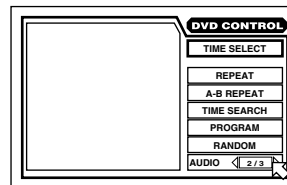

(for Video CD)

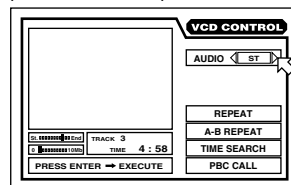

3 Use CURSOR <left>/<right> or AUDIO - S.FREQ for audio selection.

Each time you press CURSOR <left>/<right> or AUDIO - S.FREQ, the audio changes.

See the following examples for audio selection.

- For DVD AUDIO/DVD VIDEO

Each time you press CURSOR <left>/<right> or AUDIO - S.FREQ, the audio language or sound changes.

Total number

Example:
 1/3 ENGLISH
 ↓
 2/3 FRENCH
 ↓
 3/3 SPANISH

Selected audio number
 Selected audio language

- For Video CD

Each time you press CURSOR <left>/<right> or AUDIO - S.FREQ, the playback audio changes as follows.

ST (stereo)
 ↓
 L
 ↓
 R

Advanced operations

NOTES

- For DVD VIDEO, the selected language may be abbreviated on the TV screen. See "Appendix A: Table of languages and their abbreviations" at the end of this manual.
- The Audio selection display will automatically disappear if you do not change the audio for several seconds.
- To turn off the Audio selection display manually, press ENTER.
- To turn off the on-screen display: Press ON SCREEN.
- When  appears on the TV screen (for a DVD VIDEO/ DVD AUDIO disc): You cannot select the audio.

Miscellaneous functions

To adjust the picture character [VFP]



The VFP (Video Fine Processor) function enables you to adjust the picture character according to the type of programming, picture tone or personal preferences.

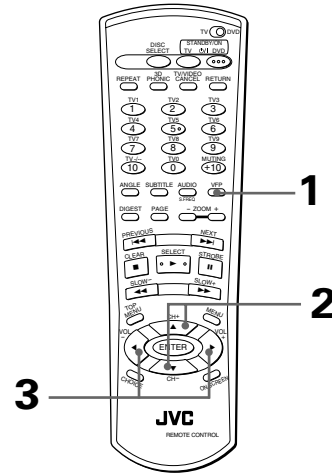

- During playback (for DVD AUDIO: During playback while picture is shown)

1 Press VFP to select the desired preset.

Each time you press the button, the preset changes as follows:

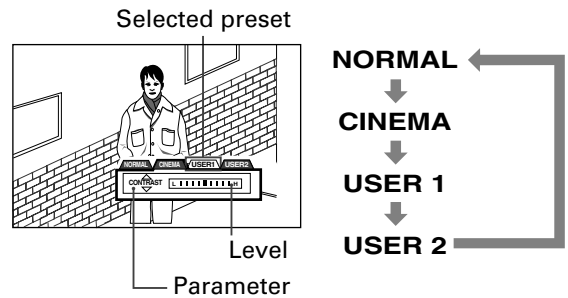

"NORMAL" and "CINEMA" are factory presets and you cannot change parameters for them. While selecting "USER 1" or "USER 2", you can adjust parameters that affect the picture character and store the settings as the user preset. See the step below.

2 To define a user setting, select a parameter to be edited using CURSOR ▲/▼ from the followings.

- **BRIGHTNESS**
Controls the brightness of the screen.
- **CONTRAST**
Controls the contrast of the screen.
- **COLOR**
Controls the color depth of the screen.
- **TINT**
Controls the tint of the screen.
- **SHARPNESS**
Controls the sharpness of the screen.
- **Y DELAY**
Controls the color gap of the screen.
- **GAMMA**
Controls the brightness of neutral tints with maintaining the brightness of dark and bright portions.

3 Adjust the level of the parameter using **CURSOR** ◀▶.

Moving the adjusting bar to the left reduces the effect, while moving the bar to the right enhances the effect.

NOTE

- The number of setting steps depends on parameters.

Hints

- The VFP screen disappears if no operations are made for more than 10 seconds. You can also turn off the VFP screen manually by pressing ENTER.

To simulate surround sound [3D PHONIC]



Using the 3D PHONIC function, you can get a simulated surround effect from your stereo system.

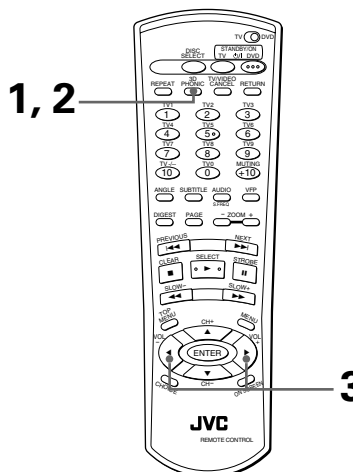

- During playback

1 Press 3D PHONIC.

The 3D PHONIC display appears on the TV screen.

2 Select the desired mode by using 3D PHONIC.

Each time you press the 3D PHONIC button, the 3D PHONIC mode changes as follows:

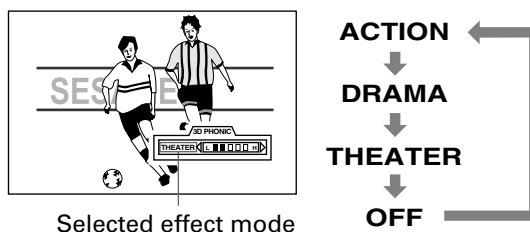

- **ACTION**
Suitable for action movies and sports programs in which sounds dynamically move.
- **DRAMA**
Natural and warm sound. You can enjoy movies in a relaxed mood.
- **THEATER**
You can enjoy sound effects like in a major theater in Hollywood.

3 Press CURSOR ◀▶ to adjust the effect level.

You can adjust the effect level in 5 steps.



Effect level

Toward L: Reduces the effect.

Toward H: Enhances the effect.

Hints

- To turn off the 3D PHONIC screen, press ENTER. The 3D PHONIC screen disappears if no operations are made for more than 10 seconds.

NOTES

- The 3D PHONIC function works correctly only when playing back a DVD VIDEO disc recorded with the Dolby Digital. With other sources, you cannot get any effect if you press the 3D PHONIC button.
- When playing back a DVD VIDEO disc recorded with the Dolby Digital that does not contain the rear signal, you cannot get a correct 3D PHONIC sound though you can change the 3D PHONIC setting.
- The 3D PHONIC function does not affect the Dolby Digital bitstream signal from the DIGITAL output jack.
- When you set the 3D PHONIC function is active, the "DOWN MIX" and "COMPRESSION" setting in the "PREFERENCE 2" display are disabled.

To check the disc time [TIME SELECT]



You can choose the time display mode for a DVD AUDIO, Audio CD or Video CD disc in the display on the front panel and in the on-screen display.

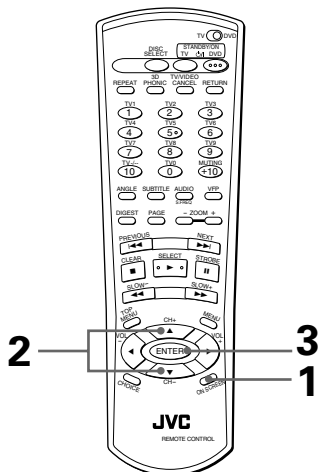

- For DVD AUDIO: During playback of audio only or while stopped
- For Audio CD: During playback or while stopped
- For Video CD: While stopped

1 Press ON SCREEN.

The on-screen display appears on the TV screen.

2 Use CURSOR ▲/▼ to move [] to [TIME SELECT].

(for DVD AUDIO)

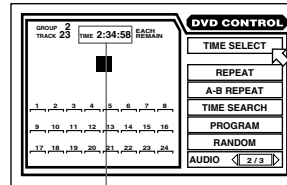

Time display

(for Audio CD)

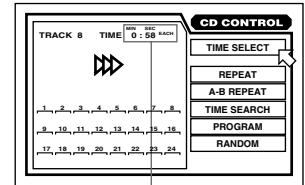

Time display

(for Video CD)

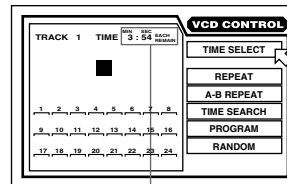

Time display

3 Press ENTER.

Each time you press ENTER, the time mode changes as follows:

- During playback (for DVD AUDIO/Audio CD)

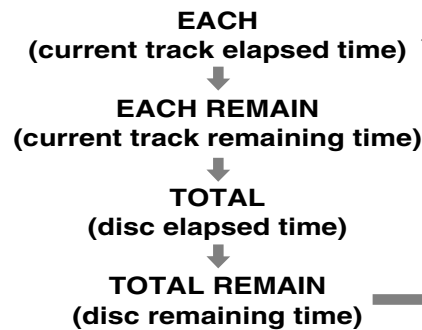

- While stopped

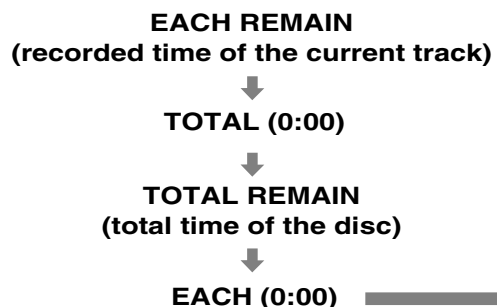

Hints

- When you select "EACH REMAIN" while stopped, you can change the track by pressing ◀▶.

To select a still picture on a DVD AUDIO disc [PAGE]



Most DVD AUDIO discs include still pictures, which usually appear in turn automatically during playback according to the playback sequence. However, there are other page(s) of the current still picture and you can change the picture (turn the page) manually.



- At the beginning of a part where there are selectable pictures, "PAGE" (or a corresponding word of the current display language) appears on the TV screen.

From normal display

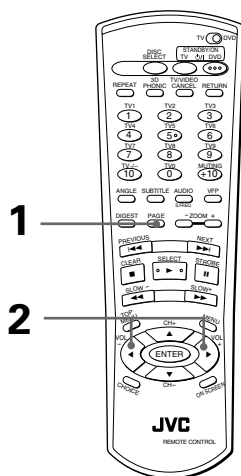

- While "PAGE" (or a corresponding word of the current display language) appears on the TV screen during playback

1 Press PAGE.

The page selection display appears on the TV screen.

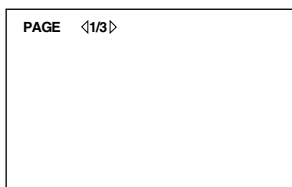

2 Use CURSOR <◀/▶> to select the desired page.

NOTE

- You can also advance to the next page by pressing the PAGE button.

From on-screen display

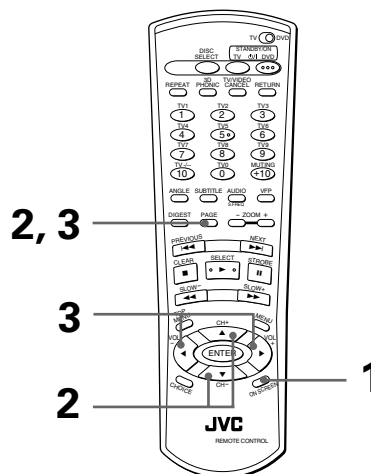

- While "PAGE" (or a corresponding word of the current display language) appears on the TV screen during playback

1 Press ON SCREEN.

The on-screen display appears on the TV screen.

2 Use CURSOR ▲/▼ or PAGE to move to [PAGE].

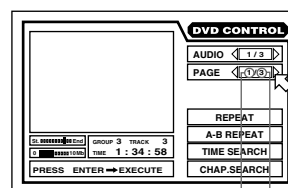

Total number

Selected page number

3 Use CURSOR <◀/▶> or PAGE to select the desired page.

Each time you press CURSOR <◀/▶>, the page changes.

To playback a bonus group of a DVD AUDIO disc



Some DVD AUDIO discs contain a special group called "bonus group" whose contents are not opened to the public. The bonus group is always assigned to the last group of a disc (for example, if a disc contains four groups including a bonus group, "group 4" is the bonus group).

To playback a bonus group, you have to enter the specific "key number" (a kind of password) for the bonus group. A way of getting the key number depends on discs.

After getting the key number, you can playback the bonus group by the following procedure.

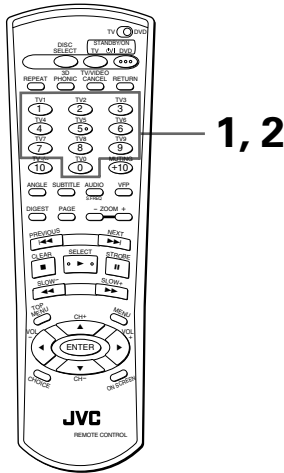

- While a disc containing a bonus group is stopped

1 Select the bonus group number (the last group) using the numeric buttons.

The display window and on-screen display prompt you to enter the key number as shown below.

(Display Window)



(TV screen)

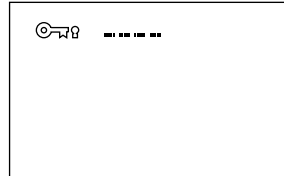

2 Enter the key number using the numeric buttons (0 to 9).

If you enter the key number correctly, the unit starts playback of the bonus group.

If you enter a wrong key number, the unit does not start playback and the display window and TV screen again prompt you to reenter the key number.

NOTES

- If you specify a track in the bonus group when programming tracks for the program playback, the display window will also show the above display for inquiring the key number.
- In the random playback mode, tracks in the bonus group are not played back.
- To turn off the key number entry display, operate any one of the following.
 - * Press ■.
 - * Open the carousel.
 - * Change the current disc.
 - * Turn the power off.

Opening the carousel, change the current disc, or turning the power off also erases the memory of the key number, while pressing ■ does not erase the memory.

Changing the brightness of the display window

You can dim the brightness of the display window.

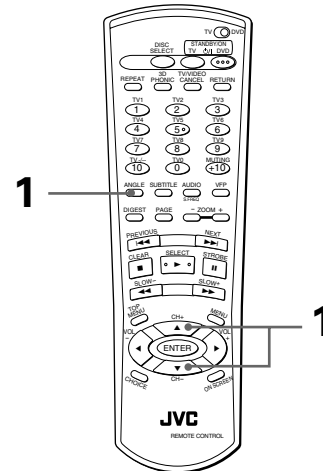

- When no disc is inserted

1 Press CURSOR ▲ or ▼ while holding down ANGLE.

You can select the brightness of the display window from among three levels or completely off.

Checking the sampling frequency



You can check the sampling frequency of digital audio during playback.

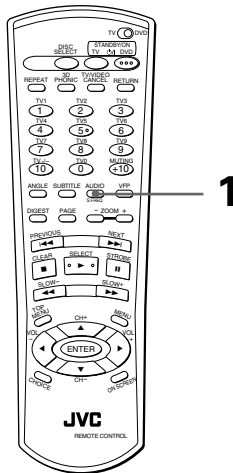

- During playback

1 Press AUDIO - S.FREQ for more than one second.

The sampling frequency of the current digital audio is shown in the display window temporarily.

NOTES

- This function is also applied to an MP3 disc.
- You cannot check the quantization bit length via the display window.
- With some disc, the sampling frequency may not be shown in the display window.

MP3 disc playback

This unit can playback CD-R discs recorded by the MP3 format (we refer to those discs as MP3 discs in this manual).
Though available functions with MP3 discs are limited, operations for the available functions are similar to those with Audio CD discs.

What is MP3?

MP3 is the abbreviation of "MPEG1 Audio Layer 3". MPEG Audio is a compression specification that compresses the audio portion only. This image compression method is used in DVD or Video CD, etc. The audio data has been compressed into about 1/10.

About MP3 disc

On an MP3 disc, each material (song) is recorded on a Track (file). Tracks are usually grouped into a "Group" (folder) by category, by artist, etc. In addition, Groups can also be members of Groups (Groups' Group), creating hierarchical Group layers. If you are familiar with personal computers, you may easily understand the hierarchical Group layer construction of MP3 discs because it is similar to the folder layer construction of computers.

This unit can handle up to 100 Tracks per Group, up to 100 Groups per Group layer and up to 10 Group layers. If a disc has more Tracks, Groups or Group layers than the above, the unit does not recognize those exceeding the maximum numbers and cannot playback them.

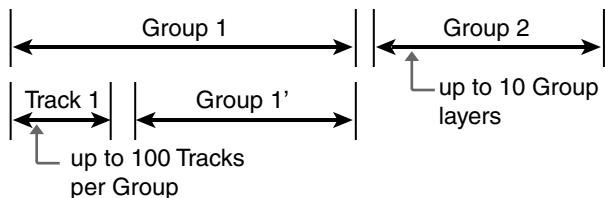

NOTES for making a private MP3 disc using a CD-R disc:

- Select "ISO 9660" as the disc format.
- Do not select the "multi-session" recording.
- Finalize the disc after completing recording.

NOTES

- The unit does not support "packet write" discs.
- Some disc may not be played back because of the disc characteristics or recording condition.
- The unit does not output a digital audio signal from DIGITAL OUT when playing back an MP3 disc.
- You cannot playback Tracks in the desired (programmed) or random order.
- The screen saver function is not active with an MP3 disc, as with an Audio CD.
- The unit only can play back Tracks with any of the following file extensions; ".MP3"; ".Mp3"; ".mp3" and ".mP3".

Operations

Basic operations

MP3

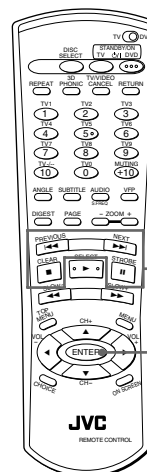

Basic control buttons

The following table shows basic functions of basic control buttons.

Buttons	Functions
	Starts playback
	Stops playback completely
	Pauses playback temporarily
	Skips back or forward a Track in the Group*

* You cannot skip a Track across a Group.

NOTES

- The current Track number is shown on the display window in the following manner.

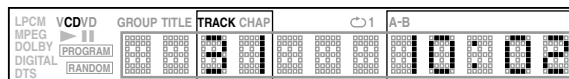

Current track elapsed time
Current track number

- Only MP3 files are shown on the display window as a track.
- Group number is not shown in the display window.
- You cannot advance or reverse playback of an MP3 disc rapidly.
- You cannot see any other time information but the current track elapsed time.
- You can check the sampling frequency of an MP3 disc. See page 53.

Specifying the desired Group and Track



When loading an MP3 disc, after the disc contents are read, the MP3 CONTROL display automatically appears on the TV screen. You can specify the desired Group and Track for playback via this display.

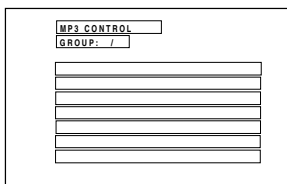

You can specify the desired Group/Track from the display by the following procedure.

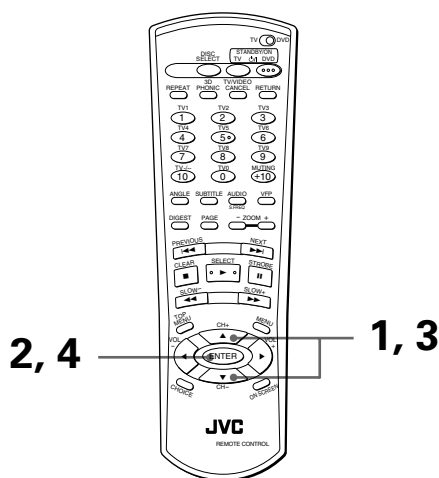

● When the MP3 selection display is shown while stopped

1 Highlight a desired Group using CURSOR ▲/▼.

2 Press ENTER.

The highlighted Group is selected, and contents of the Group is shown.

- If tracks in the selected Group are shown, go to the next step.
- If there are one or more Groups in the selected Group, repeat steps 1 and 2 until tracks in the selected Group are shown.

3 Highlight a desired Track using CURSOR ▲/▼.

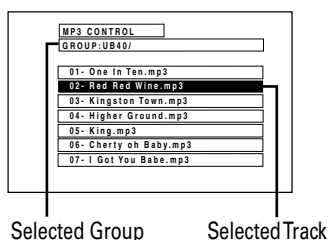

4 Press ENTER.

The unit starts playback from the specified Track. During playback, the bottom row of the display shows something like below.

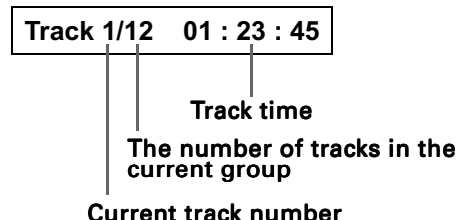

NOTES

- If a MP3 file name includes any 2-byte character, the unit may not show the file name correctly.
- You can select (highlight) a track which does not belong to any Group (if there is any). In this case, pressing ENTER immediately starts playback.
- Pressing the CURSOR ◀ button returns to the higher hierarchical layer of the Group.
- Only MP3 files are shown on the MP3 CONTROL display.
- The order of Groups/Tracks shown in the MP3 CONTROL display may differ from the order shown on your personal computer when you set the disc on your computer.

Repeat playback

MP3

You can repeat playback of the current track or group.

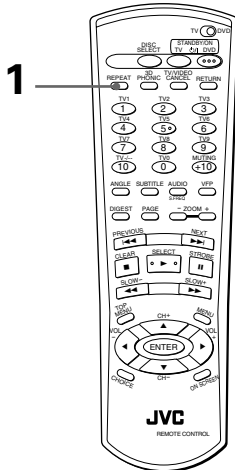

- During playback or while stopped

1 Press REPEAT.

Each time you press REPEAT, the repeat mode toggles among current group repeat, current track repeat and off.

You can see the selected mode by icons in the display window on the front panel as below.

- ⌚: Repeats the current group on the disc.
- ⌚1: Repeats the current track.
- No indication: The repeat mode is off.

- **To stop repeat playback**

Press ■.

- **To quit repeat playback**

Press REPEAT as many times until no repeat icon is shown on the display window.

NOTE

- You cannot repeat all contents on disc.

Selecting preferences

You can set various preferences for playback via two preference displays.

How to set preferences

You can bring up a preference display at any time except the unit is turned off.

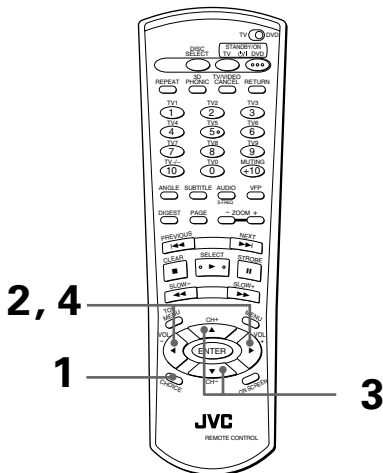

- In any condition except the unit is turned off.

1 Press CHOICE.

One of the Preference on-screen displays appears on the TV monitor.

You can see three tabs for the displays (PREFERENCE 1, PREFERENCE 2 and SPK. SETTING) at the top.

2 Select the appropriate tab using CURSOR

when points either one of the tabs.

PREFERENCE 1

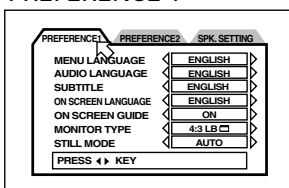

PREFERENCE 2

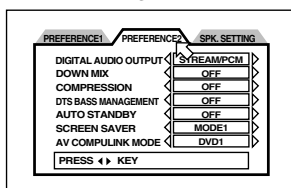

SPK.SETTING

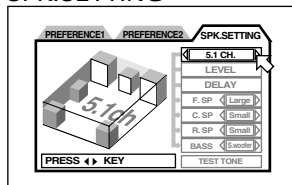

- 3 Move to select the item you want to edit by using CURSOR .

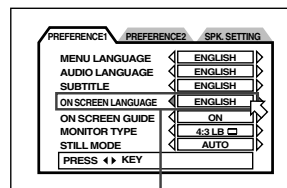

Selected item

- 4 Press CURSOR to select from options.

- For details about each setting, see the following paragraphs:

NOTES

- To return the normal screen:
Press CHOICE.
- If you bring up a "PREFERENCE" display during DVD VIDEO/Video CD playback, the unit memorizes the current playback position, and resumes playback from that position later when dismissing the "PREFERENCE" display.

Language and display preference

The "PREFERENCE 1" display handles preferences related to language and display.

MENU LANGUAGE

You can select the default "display" language to be displayed if it is contained on a DVD VIDEO/DVD AUDIO disc.

Each time you press CURSOR , the language setting changes in the following order:

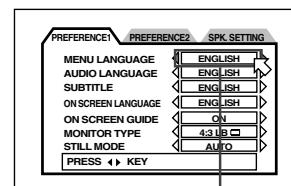

Selected language

ENGLISH → SPANISH → FRENCH → CHINESE → GERMAN → ITALIAN → JAPANESE → language code from AA to ZU

(See "Appendix A: Table of languages and their abbreviations" at the end of this manual.)

Pressing CURSOR changes the language setting in the reverse order of the above.

- * If the selected language is not recorded, the disc's default display language will be displayed.

AUDIO LANGUAGE

You can select the default audio language to be played if it is contained on a DVD VIDEO/DVD AUDIO disc.

Each time you press CURSOR ►, the language setting changes in the following order:

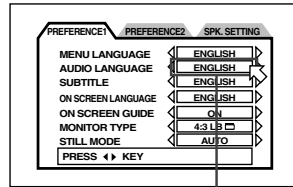

Selected language

ENGLISH → SPANISH → FRENCH → CHINESE → GERMAN → ITALIAN → JAPANESE → language code from AA to ZU

(See "Appendix A: Table of languages and their abbreviations" at the end of this manual.)

Pressing CURSOR ◀ changes the language setting in the reverse order of the above.

* If the selected language is not recorded, the disc's default audio language will be played.

SUBTITLE

You can select the default subtitle language to be displayed if it is contained on a DVD VIDEO/DVD AUDIO disc.

Each time you press CURSOR ►, the language setting changes in the following order:

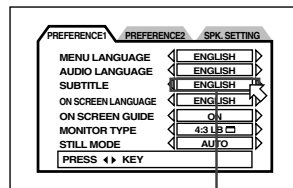

Selected language

ENGLISH → SPANISH → FRENCH → CHINESE → GERMAN → ITALIAN → JAPANESE → language code from AA to ZU → OFF

(See "Appendix A: Table of languages and their abbreviations" at the end of this manual.)

Pressing CURSOR ◀ changes the language setting in the reverse order of the above.

* If the selected language is not recorded, the disc's default subtitle language will be displayed.

ON SCREEN LANGUAGE

You can select the on-screen display language of the unit.

Each time you press CURSOR ►, the language setting changes as follows:

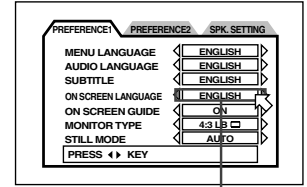

Selected language

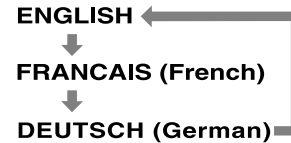

English	ON SCREEN LANGUAGE ◀ ENGLISH ▶
French	LANGUE D'ECRAN ◀ FRANCAIS ▶
German	BILDSCHIRMMENUE-SPRACHE ◀ DEUTSCH ▶

Pressing CURSOR ◀ changes the language setting in the reverse order of the above.

ON SCREEN GUIDE

The unit can display "on-screen guide" icons or characters on the picture, which show what is happening to the disc or the unit.

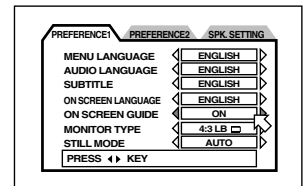

Examples of "on-screen guide" icons or characters:



- **ON**
The on-screen guide will be displayed.
- **OFF**
The on-screen guide will not be displayed.

MONITOR TYPE

You can select the monitor type to match your TV when you playback DVD VIDEO discs recorded for wide screen televisions.

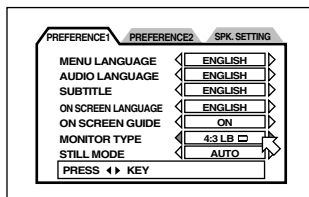

- **4:3 LB. (Letter Box Conversion)**

Should be selected when you connect a normal TV to the unit.

When you play a wide picture recorded on a DVD VIDEO disc, the picture is displayed with bands across the upper and lower portions of the screen.



- **4:3 PS. (Pan Scan Conversion)**

Should be selected when you connect a normal TV to the unit.

When you play a wide picture recorded on a DVD VIDEO disc, a portion of the picture is automatically cut off from the left and right sides of the image.

Depending on the disc, it may not be possible to playback in this mode. In that case, the picture is played back as in 4:3 LB. mode.

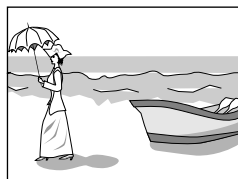

- **16:9 AUTO (Wide Television screen)**

Should be selected when you connect a wide-screen TV to the unit.

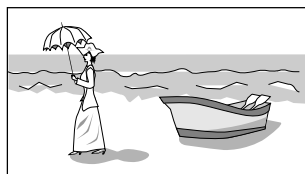

- **16:9 NORMAL (Wide Television screen)**

Should be selected when you connect the unit to a wide-screen TV whose aspect ratio is fixed to 16:9 (the unit automatically adjusts the screen width of the output signal correctly when playing back a "4:3" source).

NOTES

- If a disc does not support "4:3 Pan Scan", the letter box screen appears even if you set the MONITOR TYPE to "4:3 PS. ".
- If you playback a "4:3" DVD VIDEO source with the "16:9 NORMAL" mode, the picture character slightly changes due to the process for converting the picture width.

STILL MODE

By selecting the still mode from the following options properly, you can get better still pictures.

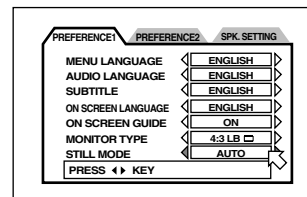

- **AUTO**

The unit recognizes the picture type (film or video source) of the current disc.

- **FIELD**

Suitable for playing back a video source disc.

- **FRAME**

Suitable for playing back a film source disc.

Audio and system preference

The "PREFERENCE 2" display handles preferences related to audio and system.

DIGITAL AUDIO OUTPUT

To connect the unit's digital output to an external device equipped with a digital input, this item must be set correctly.

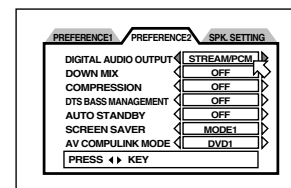

- **PCM ONLY**

Should be selected when you connect the DIGITAL OUT jack of the unit to the linear PCM digital input of other audio equipment.

- **STREAM/PCM**

Should be selected when you connect to the digital input of an amplifier with a built-in DTS, Dolby Digital, or MPEG multichannel decoder.

- **DOLBY DIGITAL/PCM**

Should be selected when you connect to the digital input of a Dolby Digital decoder, or an amplifier with a built-in Dolby Digital decoder.

The following chart shows the relationship between types of playback discs and output signals.

Playback discs	Output		
	STREAM/PCM	DOLBY DIGITAL/PCM	PCM ONLY
DVD with 48/44.1 kHz, 16 bit linear PCM	48/44.1 kHz, 16 bit, stereo linear PCM	←	←
DVD with 48/44.1 kHz, 20/24 bit linear PCM	48/44.1 kHz, 16 bit, stereo linear PCM*	←	←
DVD with 96/88.2 kHz, linear PCM	No output	←	←
DVD with 192/176.4 kHz, 16/22/24 bit linear PCM	No output	←	←
DVD with DTS	DTS bitstream	48 kHz, 16 bit, stereo linear PCM*	←
DVD with Dolby Digital	Dolby Digital bitstream	←	48 kHz, 16 bit, stereo linear PCM*
DVD with MPEG Multichannel	MPEG bitstream	48 kHz, 16 bit, stereo linear PCM	←
Video CD	44.1 kHz, 16 bit, stereo linear PCM	←	←
Audio CD	44.1 kHz, 16 bit, stereo linear PCM	←	←
Audio CD with DTS	DTS bitstream	44.1 kHz, 16 bit, stereo linear PCM	←
CD-R with MP3	No output	←	←

* With some DVD VIDEO discs that are not fully copy-protected, a 20 or 24 bit digital signal may be output.

NOTE

- When playing a DVD VIDEO or Audio CD disc with DTS, use a DTS decoder to get correct signals from your speakers.

DOWN MIX

To playback a DVD VIDEO disc recorded with surround multichannel audio correctly, the DOWN MIX setting must be properly made according to your audio system.

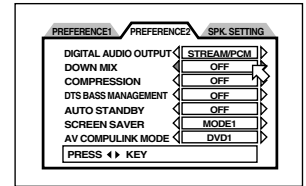

Note that this setting affects only the output signal from the ANALOG AUDIO output jacks when playing back a DVD VIDEO disc recorded with surround multichannel audio.

- **Lt/Rt**
Should be selected when you enjoy multichannel surround audio by connecting the unit's ANALOG AUDIO output to a surround decoder.
- **Lo/Ro**
Should be selected when you enjoy conventional 2-channel stereo audio by connecting the unit's AUDIO output to a stereo amplifier/receiver or television set, or when you duplicate audio of a DVD VIDEO disc recorded with surround audio to your MD, cassette, etc.
- **OFF**
When you enjoy multichannel surround audio by connecting the unit's 5.1-channel audio outputs to an amplifier equipped with 5.1-channel inputs.

NOTES

- The "DOWN MIX" function does not work when the 3D PHONIC function is activated.
- Some DVD AUDIO discs prohibit the 2-channel down-mix. For such a disc, you cannot get the down-mixed signal even if you set "DOWN MIX" to "Lt/Rt" or "Lo/Ro".

COMPRESSION (only for Dolby Digital DVD VIDEO Discs)

When enjoying a DVD VIDEO disc recorded with the Dolby Digital format at low or middle volume, setting COMPRESSION to ON makes you hear sound comfortably.

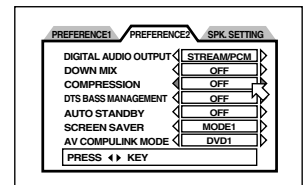

- **ON**
Audio is played back with the dynamic range compressed.
- **OFF**
Audio is played back as it was recorded.

NOTES

- The "COMPRESSION" function works only when playing back a disc recorded with DOLBY DIGITAL. The setting is not effective for other discs.
- The "COMPRESSION" function does not work when the 3D PHONIC function is activated.

DTS BASS MANAGEMENT

This item controls the output signals when playing back DTS-encoded DVD VIDEO discs.

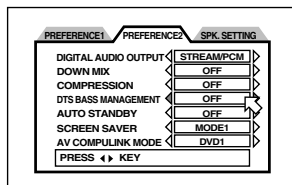

- **OFF**

This is the normal setting for DTS-encoded discs. Signals with the full frequency range are output from all speakers when playing back a DTS-encoded disc. This mode ignores all "Small" settings in the speaker setting screen (All "Small" settings are regarded as "Large").

- **ON**

All speaker settings (front, center and rear) in the speaker setting screen are effective when playing back DTS-encoded discs. The low frequency signal fed from the sub-woofer output is boosted up regardless of the "Bass redirect setting" in the speaker setting screen.

See page 62 for the speaker setting screen.

AUTO STANDBY

When the unit is stopped for more than 30 minutes or 60 minutes, the unit enters standby mode automatically.

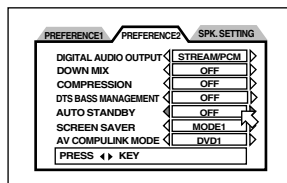

- **60**

Time is set to 60 minutes.

- **30**

Time is set to 30 minutes.

- **OFF**

The auto standby function is off.

SCREEN SAVER

A television monitor screen may be burned out if a static picture is displayed for a long time. To prevent this, the unit automatically activates the screen saver function if a static picture, such as an on-screen display or menu, is displayed for over 5 minutes.

- **MODE 1**

The current picture gets dark.

- **MODE 2**

The "screen saver" picture appears and its brightness changes.

- **OFF**

The screen saver function is off.

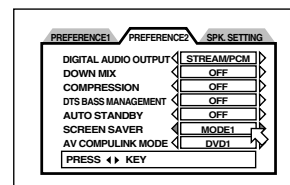

NOTES

- The monitor screen of a projector or projection TV is easily burned out if a static picture is displayed for a long time. Be careful not to allow the monitor screen to be burned out when you set the SCREEN SAVER mode to "OFF".
- The TV screen may be garbled when you set the SCREEN SAVER mode to "MODE 1". In this case, set to another mode.
- When a static picture is displayed for a long time during playback, the screen saver function is always activated in "MODE 1" regardless of whether you select "MODE 1" or "MODE 2".

AV COMPULINK MODE

This item is provided for use in the future. Leave it as the default setting ("DVD1").

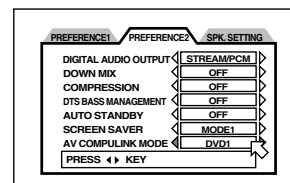

Speaker setting

Speaker Channel setting

Select the speaker configuration type according to your speaker system. Normally, simply select "5.1 CH." or "2 CH.:" However, by selecting "EXPERT", you can make fine tuning to match your speaker system.

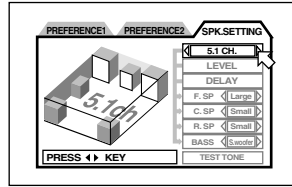

- **2 CH.**
When you connect to a 2-channel amplifier or TV.
- **5.1 CH.**
When you connect to a 5.1-channel amplifier and use the front, rear, center and sub-woofer speakers.
- **EXPERT**
When you want to make fine tuning to match your speakers. The following five setting items are available.

NOTES

- When selecting "5.1 CH." or "EXPERT", set "DOWN MIX" to "OFF" (see page 60).
- The Dolby Digital LFE (Low Frequency Effect) signal is always fed from the SUBWOOFER output on the rear panel of the unit regardless of speaker setting.
- If you connect the unit's digital output to an external Dolby Digital or DTS decoder (and set the "DIGITAL AUDIO OUTPUT" option to "STREAM/PCM"), the speaker setting above is not effective. Make the speaker setting of the external decoder properly.

Speaker size settings (available only when selecting EXPERT)

Sets the speaker sizes according to your speakers.

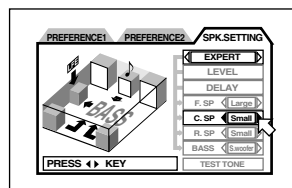

1 Select the speaker to be set using CURSOR ▲/▼.

- **F.SP** : Front speakers
- **C.SP** : Center speaker
- **R.SP** : Rear speakers

2 Select the size using CURSOR ◀/▶.

- **Large**: Large speaker(s) which can fully reproduce the low-frequency range.
- **Small**: Small speaker(s) which can not fully reproduce the low-frequency range.
- **None**: No speaker(s) connected.

If you set the front speakers to "Small", you cannot set the other speakers to "Large".

Bass redirect (available only when selecting EXPERT)

When you use small speakers which do not fully reproduce the low-frequency range, you can boost up the low-frequency signal of the sub-woofer or front speakers.

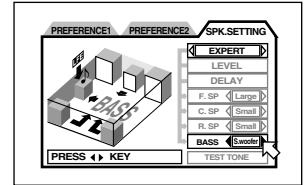

1 Select [BASS] using CURSOR ▲/▼.

2 Select [S.woofer] or [L/R] using CURSOR ◀/▶.

- **S.woofer**: The low-frequency signal fed from the sub-woofer output is boosted up.
- **L/R**: The low-frequency signals fed from the front speaker outputs are boosted up.

The "Bass redirect" setting is effective only when at least any one of the speaker sizes is set to "Small". If none of them is set to "Small", this setting is not activated ("None" appears in the setting field). Please note that the "L/R" setting is effective only when playing back a Dolby Digital encoded DVD VIDEO disc. If the front speaker size is set to "Small", the Bass redirect setting is fixed to "S.woofer".

Speaker level (available only when selecting EXPERT)

You can adjust the output level of each speaker.

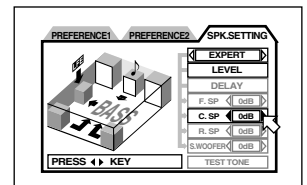

1 Select [LEVEL] using CURSOR ▲/▼, then press ENTER.
The color of "LEVEL" changes.

2 Select the desired speaker(s) to be set using CURSOR ▲/▼.

- **F.SP** : Front speakers. The level is fixed to 0dB.
- **C.SP** : Center speaker
- **R.SP** : Rear speakers
- **S.WOOFER**: Sub-woofer

The setting range is between -6dB and +6dB in 1dB steps.

3 Set the level using CURSOR ◀/▶.

Hints

- For the speaker(s) whose size is set to "None," the Speaker level and Delay cannot be set ("—" appears in the setting field).
- However, when playing back a Dolby Digital disc, LFE signal is output from SUBWOOFER output even if S.WOOFER shows "—"; allowing to activate a sub-woofer connected. In such case, adjust the output level using the level control on the sub-woofer.

Delay

(available only when selecting EXPERT)

You can adjust the delay time of each speakers.

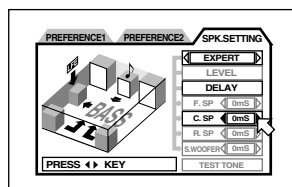

1 Select [DELAY] using CURSOR ▲/▼, then press ENTER.

The color of "DELAY" changes.

2 Select the desired speaker(s) to be set using CURSOR ▲/▼.

- **F.SP** : Front speakers. The delay is fixed to 0ms.
- **C.SP** : Center speaker (selectable from 0 to -5ms in 1 ms units)
- **R.SP** : Rear speakers (selectable from 0 ms, -5ms, -10 ms, and -15 ms)

3 Set the delay time using CURSOR ◀/▶.

Hints

- Delay of S.WOOFER cannot be set.

NOTE

- **To exit the speaker level (or delay) setting mode**
Move ◀ to [LEVEL] (or [DELAY]) in the on-screen display and press ENTER until [LEVEL] (or [DELAY]) returns to its original color.

Test tone (available only while setting LEVEL or DELAY)

You can check the level setting by monitoring the test tone.

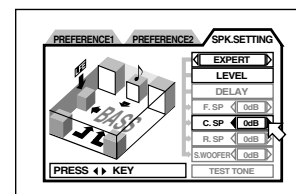

1 Select [TEST TONE] using CURSOR ▲/▼, then press ENTER.

The color of "TEST TONE" changes.

2 Select the desired speaker(s) using CURSOR ▲/▼.

- **F.SP** : Front speakers
- **C.SP** : Center speaker
- **R.SP** : Rear speakers

After selecting the Test tone, if you do not move the cursor, the test tone is output from each speaker one by one.

In Test tone mode, if you move ◀ down from "R.SP" position, the test tone continues to output from the rear speakers as long as ◀ is any position other than "F.SP" and "C.SP". Similarly, if you move ▶ up from "F.SP" position, the test tone continues to output from the front speakers as long as ▶ is any position other than "C.SP" and "R.SP".

3 Set the level using CURSOR ◀/▶ again, if necessary.

Hints

- In Test tone mode, you hear pink noise, which includes all frequencies in the audible range, from the speakers. This is not a malfunction.
- The test tone is not output from the SUBWOOFER output.

NOTE

- **To exit the test tone mode**

Move ◀ to [TEST TONE] in the on-screen display and press ENTER until [TEST TONE] returns to its original color.

Limiting playback by children

This function restricts playback of DVD VIDEO discs which contain violent (and other) scenes according to the level set by the user. For example, if a movie which includes violent scenes supports the parental lock feature, such scenes which you do not want to let children view can be cut or replaced with other scenes.

To set Parental Lock for the first time [PARENTAL LOCK]

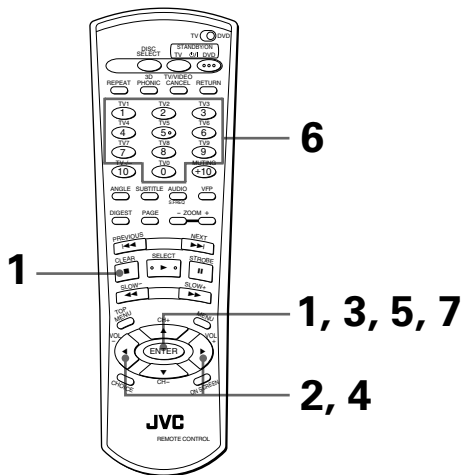

- While a DVD VIDEO disc is stopped or no disc is inserted

1 Press ENTER while holding down ■ on the remote control unit.
The Parental Lock on-screen display appears on the TV screen.
↵ points [Country Code].

2 While ↵ points [Country Code], use CURSOR ◀▶ to select the country code.
The country code whose standards were applied to rate the DVD VIDEO disc should be selected. See "Appendix B: Country code list for Parental Lock".

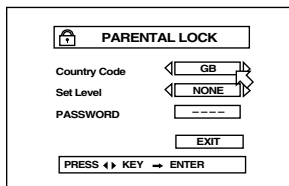

3 Press ENTER.
↵ moves to [Set Level].

4 While ↵ points [Set Level], use CURSOR ◀▶ to select the Parental Lock level.

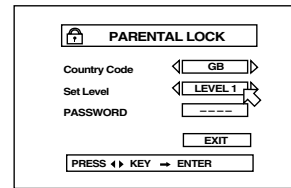

Each time you press CURSOR ◀▶, the parental level changes as follows:

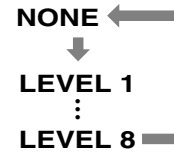

- "LEVEL1" is the strictest level. "NONE" means no restriction. Discs rated higher than the selected level are restricted.

5 Press ENTER.
↵ moves to [PASSWORD].

6 Enter your 4-digit password using the numeric buttons (0 to 9).

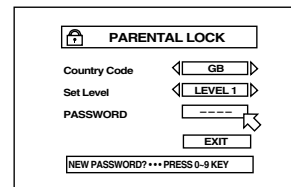

7 Press ENTER.
The parental level and password are set.
↵ moves to [EXIT].
Pressing ENTER again returns to the opening display.



- If you enter an undesired password in step 6 above, reenter the password before pressing ENTER.

To change the settings [PARENTAL LOCK]



You can change the Parental Lock settings later.

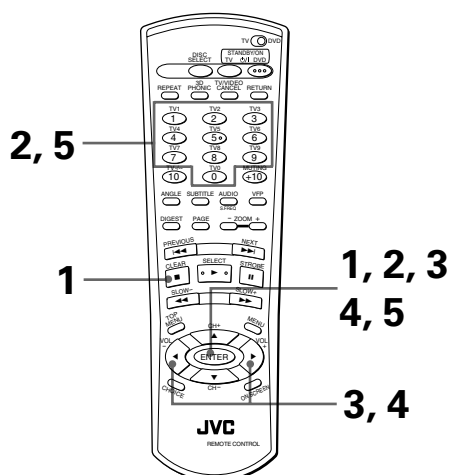

- While a DVD VIDEO disc is stopped or no disc is inserted

1 Press ENTER while holding down ■ on the remote control unit.

The Parental Lock on-screen display appears on the TV screen.

↵ points [PASSWORD].

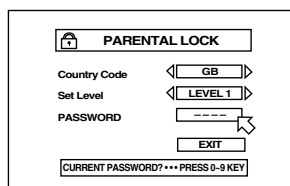

2 Enter your current 4-digit password using the numeric buttons (0 to 9) and press ENTER.

↵ moves to [Country Code] if you enter the correct password.

If you enter the wrong password, "WRONG! RETRY..." appears on the TV screen, and you cannot go to the next step.

3 To change the country code, use CURSOR ◀/▶ to select the desired country code and press ENTER.

↵ moves to [Set Level].

When you change the country code, you must select the parental level.

4 To change the set level, use CURSOR ◀/▶ to select the desired level while ↵ points [Set Level], and then press ENTER.

↵ moves to [PASSWORD].

5 Enter the password using the numeric buttons (0 to 9) and press ENTER.

↵ moves to [EXIT].

The password entered in the above step becomes the new password. If you do not change the password, enter the same password as in the step 2. Even if you want to change only the country code and/or parental level, do not forget to enter the password after changing the country code and/or parental level. Otherwise, the new country code and/or parental level will not become effective. Pressing ENTER again returns to the opening display.

NOTES

- When you enter the wrong password more than 3 times in step 2 above, ↵ moves to [EXIT] automatically and CURSOR ▲/▼ does not work.
- If you forget your password in step 2 Enter "8888."

To temporarily release the Parental Lock [PARENTAL LOCK]



When you set the parental level strictly, some discs may not be played back at all. When you insert such a disc and try to play it, the following Parental Lock on-screen display appears on the TV screen, asking you whether you want the Parental Lock to be temporarily released or not.

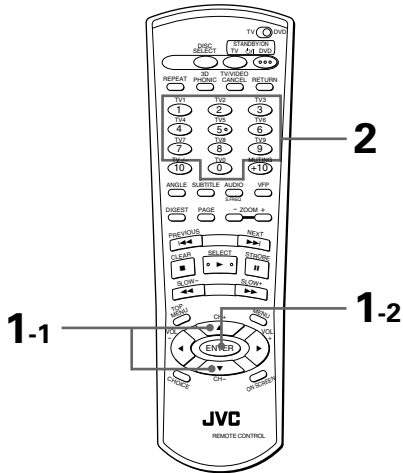

1 Use the CURSOR ▲/▼ to move to [YES], then press ENTER.

moves to the PASSWORD field. When selecting [NO], press ▲ (OPEN/CLOSE) to remove the disc.

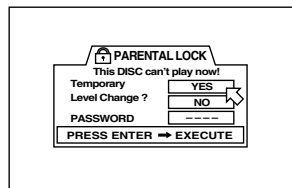

2 Enter your 4-digit password using the numeric buttons (0 to 9).

The Parental Lock is released, and the unit starts playback.

If you enter the wrong password, "WRONG! RETRY..." appears on the TV screen.

Enter the correct password.

NOTE

- When you enter the wrong password more than 3 times in step 2 above, moves to [NO] automatically and CURSOR ▲/▼ do not work.

Care and handling of discs

How to handle discs

When handling a disc, do not touch the surface of the disc. Since discs are made of plastic, they are easily damaged. If a disc gets dirty, dusty, scratched or warped, the images and sound will not be picked up correctly, and such a disc may cause the player to malfunction.

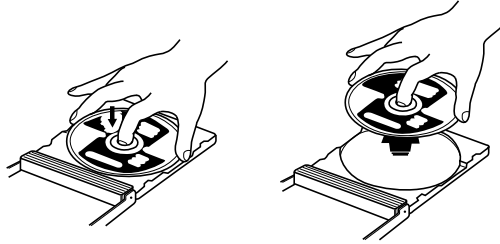

Label side

Do not damage the label side, stick paper to or use any adhesive on its surface.

Storage

Make sure that discs are kept in their cases. If discs are piled on top of one another without their protective cases, they can be damaged. Do not put discs in a location where they may be exposed to direct sunlight, or in a place where the humidity or temperature is high. Avoid leaving discs in your car!

Maintenance of discs

If there are fingerprints or other dirt adhering to a disc, wipe with a soft dry cloth, moving from the center outwards. If a disc is difficult to clean, wipe with a cloth moistened with water. Never use record cleaners, petrol, alcohol or any anti-static agents.

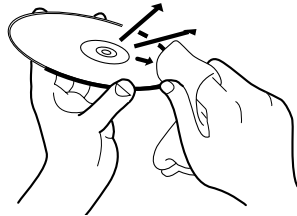

CAUTION

Sometimes during play noise or images may be garbled. This is sometimes due to the disc. (It may not be up to industry standards.)

These symptoms are caused by the discs, not by the malfunction of the unit.

Troubleshooting

What appears to be a malfunction may not always be serious. Please go through the following list before requesting service.

Symptom	Possible case	Remedy
Power does not come on.	Power plug is not inserted securely.	Plug in securely.
Remote control does not work.	Too far from the unit.	Move closer to the unit.
	The tip of the remote unit is not pointed in the right direction.	Point the infrared light-emitting window toward the remote sensor on the front panel.
	Batteries are exhausted.	Replace the batteries with new ones.
	Battery polarity is incorrect.	Take out the batteries and insert them again in the correct direction.
The TV/VIDEO - CANCEL, CURSOR or numeric buttons do not work.	The TV - DVD switch is not correctly set.	To control the unit, set the TV - DVD switch to "DVD". To control your TV, set the TV - DVD switch to "TV".
No picture is displayed on the monitor.	Connection of video cable is incorrect.	Connect the cable correctly.
	Input selection of TV is incorrect.	Select correctly.
	Disc is not playable.	Use a playable disc. (See page 15.)
Picture is not normal when using the VIDEO or S-VIDEO jack.	The Y/C - COMP. switch is not set correctly.	Set the Y/C - COMP. switch correctly. (See page 10.)
Picture is noisy or blurred.	The unit is connected to a VCR directly and the copyguard function is activated.	Connect the unit so that the picture signal flows directly to the TV.
No audio is reproduced.	Connection is incorrect.	Check the connections.
	Input selection of amplifier is incorrect.	Select correctly.
No audio is reproduced when playing back a DVD disc recorded with High-sampling (88.2 kHz or more) linear PCM audio using the DIGITAL OUT jack.	The audio signal is not derived from the unit's DIGITAL OUT.	Use the AUDIO OUT when playing back such discs.
There is no sound. NO AUDIO is displayed.	The disc has been illegally copied.	Consult with disc vendor.
Sound is distorted or noise is generated.	Disc is dirty.	Wipe the disc surface.
Picture does not fit the television screen.	MONITOR TYPE is not correctly set.	Select monitor type correctly. (See page 59.)
	Television is not correctly set.	Set the television correctly.
Operation is not possible.	Microcomputer malfunction due to lightning or static electricity.	Turn off the power and unplug the power cord, then connect the power cord again.
	Moisture condensation caused by a sudden change of temperature or humidity.	Turn off the power, then turn it on a few hours later.
The carousel does not move.	The system malfunctions. An alien substance is jammed on the carousel.	Press the STOP button or turn off the power.
The display window does not light when the STANDBY/ON  indicator on the front panel is lit in green.	The brightness of the display window is set to "off".	Change the brightness of the display window. (See page 52.)

Specifications

General

Readable discs: DVD AUDIO, DVD VIDEO, Audio CD, Video CD
 Video format: PAL

Other

Power requirements: AC 230 V \sim , 50 Hz
 Power consumption: 18 W (POWER ON), 2.7 W (STANDBY mode)
 Mass: 5.6 kg
 Dimensions (W x H x D): 435 mm x 102 mm x 448 mm

Video outputs

VIDEO OUT (pin jack): 1.0 Vp-p (75 Ω)
 S-VIDEO OUT (S jack):
 Y Output: 1.0 Vp-p (75 Ω)
 C Output: 300 mVp-p (75 Ω)
 RGB out: 0.7 Vp-p (75 Ω)
 Horizontal resolution: 500 Lines or more

Audio outputs

ANALOG OUT (pin jack): 2.0 Vrms (10 k Ω)
 DIGITAL OUT: (COAXIAL): 0.5 Vp-p (75 Ω termination)
 (OPTICAL): -21 dBm to -15 dBm (Peak)

Audio characteristics

Frequency response:
 CD (sampling frequency 44.1 kHz): 2 Hz to 20 kHz
 DVD (sampling frequency 48 kHz): 2 Hz to 22 kHz
 (2 Hz to 20 kHz for DTS and Dolby Digital bitstream signals)
 DVD (sampling frequency 96 kHz/88.2 kHz): 2 Hz to 44 kHz
 DVD (sampling frequency 192 kHz/176.4 kHz): 2 Hz to 88 kHz

Dynamic range:
 16 bit: More than 100 dB
 20 bit/24 bit: More than 108 dB

Wow and flutter: Unmeasurable (less than \pm 0.002%)

Total harmonic distortion:
 16 bit: Less than 0.0018%
 20 bit/24 bit: Less than 0.0012%

* Specifications and appearance subject to change without prior notice.

Appendix A: Table of languages and their abbreviations

When you select the subtitle language or sound, the languages shown below are displayed as abbreviations. To select the desired language, select the abbreviation corresponding the language you want to.

AA	Afar
AB	Abkhazian
AF	Afrikaans
AM	Ameharic
AR	Arabic
AS	Assamese
AY	Aymara
AZ	Azerbaijani
BA	Bashkir
BE	Byelorussian
BG	Bulgarian
BH	Bihari
BI	Bislama
BN	Bengali, Bangla
BO	Tibetan
BR	Breton
CA	Catalan
CO	Corsican
CS	Czech
CY	Welsh
DA	Danish
DZ	Bhutani
EL	Greek
EO	Esperanto
ET	Estonian
EU	Basque
FA	Persian
FI	Finnish
FJ	Fiji
FO	Faroese
FY	Frisian
GA	Irish
GD	Scots Gaelic
GL	Galician
GN	Guarani
GU	Gujarati
HA	Hausa
HI	Hindi
HR	Croatian
HU	Hungarian
HY	Armenian
IA	Interlingua
IE	Interlingue

IK	Inupiak
IN	Indonesian
IS	Icelandic
IW	Hebrew
JI	Yiddish
JW	Javanese
KA	Georgian
KK	Kazakh
KL	Greenlandic
KM	Cambodian
KN	Kannada
KO	Korean (KOR)
KS	Kashmiri
KU	Kurdish
KY	Kirghiz
LA	Latin
LN	Lingala
LO	Laothian
LT	Lithuanian
LV	Latvian, Lettish
MG	Malagasy
MI	Maori
MK	Macedonian
ML	Malayalam
MN	Mongolian
MO	Moldavian
MR	Marathi
MS	Malay (MAY)
MT	Maltese
MY	Burmese
NA	Nauru
NE	Nepali
NL	Dutch
NO	Norwegian
OC	Occitan
OM	(Afan) Oromo
OR	Oriya
PA	Panjabi
PL	Polish
PS	Pashto, Pushto
PT	Portuguese
QU	Quechua
RM	Rhaeto-Romance

RN	Kirundi
RO	Rumanian
RU	Russian
RW	Kinyarwanda
SA	Sanskrit
SD	Sindhi
SG	Sangho
SH	Serbo-Croatian
SI	Singhalese
SK	Slovak
SL	Slovenian
SM	Samoan
SN	Shona
SO	Somali
SQ	Albanian
SR	Serbian
SS	Siswati
ST	Sesotho
SU	Sundanese
SV	Swedish
SW	Swahili
TA	Tamil
TE	Telugu
TG	Tajik
TH	Thai
TI	Tigrinya
TK	Turkmen
TL	Tagalog
TN	Setswana
TO	Tonga
TR	Turkish
TS	Tsonga
TT	Tatar
TW	Twi
UK	Ukrainian
UR	Urdu
UZ	Uzbek
VI	Vietnamese
VO	Volapuk
WO	Wolof
XH	Xhosa
YO	Yoruba
ZU	Zulu

Appendix B:Country code list for Parental Lock

This list is used for the Parental Lock operation. For details, see page 64.

AD	Andorra
AE	United Arab Emirates
AF	Afghanistan
AG	Antigua and Barbuda
AI	Anguilla
AL	Albania
AM	Armenia
AN	Netherlands Antilles
AO	Angola
AQ	Antarctica
AR	Argentina
AS	American Samoa
AT	Austria
AU	Australia
AW	Aruba
AZ	Azerbaijan
BA	Bosnia and
BB	Barbados
BD	Bangladesh
BE	Belgium
BF	Burkina Faso
BG	Bulgaria
BH	Bahrain
BI	Burundi
BJ	Benin
BM	Bermuda
BN	Brunei Darussalam
BO	Bolivia
BR	Brazil
BS	Bahamas
BT	Bhutan
BV	Bouvet Island
BW	Botswana
BY	Belarus
BZ	Belize
CA	Canada
CC	Cocos (Keeling) Islands
CF	Central African Republic
CG	Congo
CH	Switzerland
CI	Côte d'Ivoire
CK	Cook Islands
CL	Chile
CM	Cameroon
CN	China
CO	Colombia
CR	Costa Rica
CU	Cuba
CV	Cape Verde
CX	Christmas Island
CY	Cyprus
CZ	Czech Republic
DE	Germany
DJ	Djibouti
DK	Denmark
DM	Dominica
DO	Dominican Republic
DZ	Algeria
EC	Ecuador
EE	Estonia
EG	Egypt
EH	Western Sahara
ER	Eritrea
ES	Spain
ET	Ethiopia
FI	Finland
FJ	Fiji
FK	Falkland Islands
FM	Micronesia (Federated States of)
FO	Faroe Islands
FR	France
FX	France, Metropolitan
GA	Gabon
GB	United Kingdom
GD	Grenada
GE	Georgia
GF	French Guiana
GH	Ghana
GI	Gibraltar
GL	Greenland
GM	Gambia
GN	Guinea
GP	Guadeloupe
GQ	Equatorial Guinea
GR	Greece
GS	South Georgia and the South Sandwich
GT	Guatemala
GU	Guam
GW	Guinea-Bissau
GY	Guyana
HK	Hong Kong
HM	Heard Island and McDonald Islands
HN	Honduras
HR	Croatia
HT	Haiti
HU	Hungary
ID	Indonesia
IE	Ireland
IL	Israel
IN	India
IO	British Indian Ocean Territory
IQ	Iraq
IR	Iran (Islamic Republic of)
IS	Iceland
IT	Italy
JM	Jamaica
JO	Jordan
JP	Japan
KE	Kenya
KG	Kyrgyzstan
KH	Cambodia
KI	Kiribati
KM	Comoros
KN	Saint Kitts and Nevis
KP	Korea, Democratic People's Republic of
KR	Korea, Republic of
KW	Kuwait
KY	Cayman Islands
KZ	Kazakhstan
LA	Lao People's Democratic Republic
LB	Lebanon
LC	Saint Lucia
LI	Liechtenstein
LK	Sri Lanka
LR	Liberia
LS	Lesotho
LT	Lithuania
LU	Luxembourg
LV	Latvia
LY	Libyan Arab
MA	Morocco
MC	Monaco
MD	Moldova, Republic of
MG	Madagascar
MH	Marshall Islands
ML	Mali
MM	Myanmar
MN	Mongolia
MO	Macau
MP	Northern Mariana Islands
MQ	Martinique
MR	Mauritania
MS	Montserrat
MT	Malta
MU	Mauritius
MV	Maldives
MW	Malawi
MX	Mexico
MY	Malaysia
MZ	Mozambique
NA	Namibia
NC	New Caledonia
NE	Niger
NF	Norfolk Island
NG	Nigeria
NI	Nicaragua
NL	Netherlands
NO	Norway
NP	Nepal
NR	Nauru
NU	Niue
NZ	New Zealand
OM	Oman
PA	Panama
PE	Peru
PF	French Polynesia
PG	Papua New Guinea
PH	Philippines
PK	Pakistan
PL	Poland
PM	Saint Pierre and Miquelon
PN	Pitcairn
PR	Puerto Rico
PT	Portugal
PW	Palau
PY	Paraguay
QA	Qatar
RE	Réunion
RO	Romania
RU	Russian Federation
RW	Rwanda
SA	Saudi Arabia
SB	Solomon Islands
SC	Seychelles
SD	Sudan
SE	Sweden
SG	Singapore
SH	Saint Helena
SI	Slovenia
SJ	Svalbard and Jan Mayen
SK	Slovakia
SL	Sierra Leone
SM	San Marino
SN	Senegal
SO	Somalia
SR	Suriname
ST	Sao Tome and Principe
SV	El Salvador
SY	Syrian Arab Republic
SZ	Swaziland
TC	Turks and Caicos Islands
TD	Chad
TF	French Southern Territories
TG	Togo
TH	Thailand
TJ	Tajikistan
TK	Tokelau
TM	Turkmenistan
TN	Tunisia
TO	Tonga
TP	East Timor
TR	Turkey
TT	Trinidad and Tobago
TV	Tuvalu
TW	Taiwan
TZ	Tanzania, United Republic of
UA	Ukraine
UG	Uganda
UM	United States Minor Outlying Islands
US	United States
UY	Uruguay
UZ	Uzbekistan
VA	Vatican City State (Holy See)
VC	Saint Vincent and the Grenadines
VE	Venezuela
VG	Virgin Islands (British)
VI	Virgin Islands (U.S.)
VN	Vietnam
VU	Vanuatu
WF	Wallis and Futuna Islands
WS	Samoa
YE	Yemen
YT	Mayotte
YU	Yugoslavia
ZA	South Africa
ZM	Zambia
ZR	Zaire
ZW	Zimbabwe



SAFETY INSTRUCTIONS

“SOME DOS AND DON'TS ON THE SAFE USE OF EQUIPMENT”

This equipment has been designed and manufactured to meet international safety standards but, like any electrical equipment, care must be taken if you are to obtain the best results and safety is to be assured.

Do read the operating instructions before you attempt to use the equipment.

Do ensure that all electrical connections (including the mains plug, extension leads and interconnections between pieces of equipment) are properly made and in accordance with the manufacturer's instructions. Switch off and withdraw the mains plug when making or changing connections.

Do consult your dealer if you are ever in doubt about the installation, operation or safety of your equipment.

Do be careful with glass panels or doors on equipment.

DON'T continue to operate the equipment if you are in any doubt about it working normally, or if it is damaged in any way—switch off, withdraw the mains plug and consult your dealer.

DON'T remove any fixed cover as this may expose dangerous voltages.

DON'T leave equipment switched on when it is unattended unless it is specifically stated that it is designed for unattended operation or has a standby mode.

Switch off using the switch on the equipment and make sure that your family know how to do this.

Special arrangements may need to be made for infirm or handicapped people.

DON'T use equipment such as personal stereos or radios so that you are distracted from the requirements of traffic safety. It is illegal to watch television whilst driving.

DON'T listen to headphones at high volume as such use can permanently damage your hearing.

DON'T obstruct the ventilation of the equipment, for example with curtains or soft furnishings.

Overheating will cause damage and shorten the life of the equipment.

DON'T use makeshift stands and **NEVER** fix legs with wood screws — to ensure complete safety always fit the manufacturer's approved stand or legs with the fixings provided according to the instructions.

DON'T allow electrical equipment to be exposed to rain or moisture.

ABOVE ALL

— **NEVER** let anyone, especially children, push anything into holes, slots or any other opening in the case — this could result in a fatal electrical shock.;

— **NEVER** guess or take chances with electrical equipment of any kind — it is better to be safe than sorry!

JVC
VICTOR COMPANY OF JAPAN, LIMITED